

# FACTORYCAT®

# MICRO-HID

## Operating Instructions (EN)

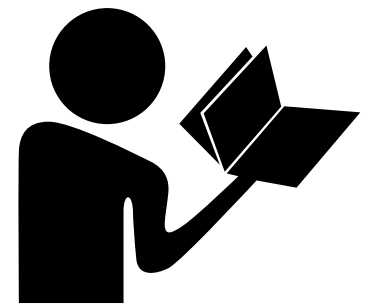
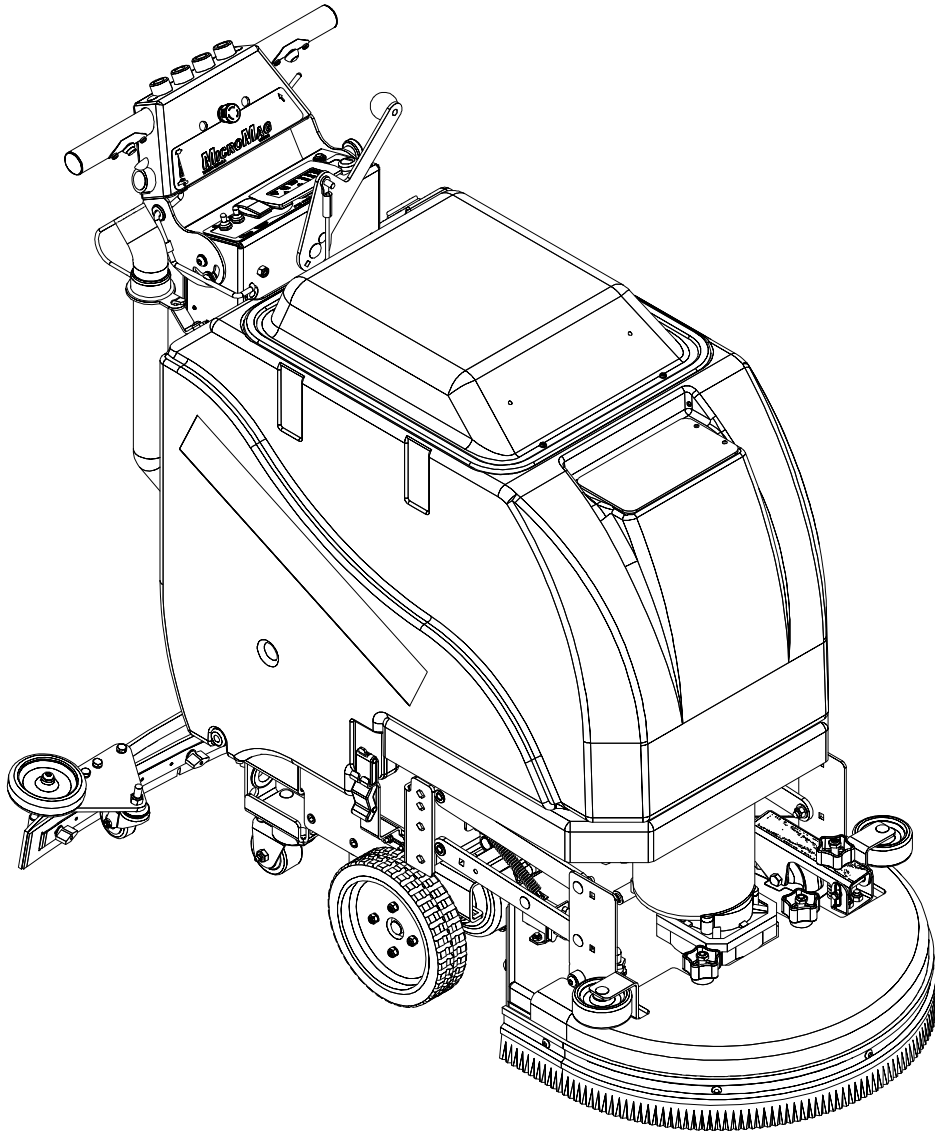

Read these Instructions before using the machine.



Read these Safety Messages before using the machine.

www.factorycat.com  
1711 South Street  
Racine, WI 53404 (USA)  
(800) 634-4060 | (+001) 262-681-3583  
© 2018 RPS Corporation

Scan With Phone for more Information



V18.234  
FC-MICRO-HD-OP-EN

## INTRODUCTION

This manual is furnished with each new machine. This manual will allow the Operator to get the best performance out of your RPS manufactured Scrubber-Drier, Sweeper, Burnisher, or Orbital Scrubber. Read this manual thoroughly before operating or servicing the machine.

This machine will provide excellent performance, but the best results will be obtained at the most minimum costs if:

- The machine is regularly maintained - per the Authorized Local Distributor.
- The machine is operated with reasonable care and caution.
- The machine is maintained with manufacturer supplied parts.

## LOCATE SERIAL NUMBER

The serial number of your machine is located on the lower half of the control panel of the machine.



AS OUR POLICY IS ONE OF CONSTANT IMPROVEMENT - ALL INFORMATION AND SPECIFICATIONS ARE SUBJECT TO CHANGE WITHOUT NOTICE.

# TABLE OF CONTENTS



<b>Introduction</b> .....	2	<b>Fill Solution Tank</b> .....	19
<b>Locate Serial Number</b> .....	2	<b>Operation - Scrubbing</b> .....	20
<b>Table Of Contents</b> .....	3	<b>Draining Recovery Tank</b> .....	21
<b>Safety Messages</b> .....	4	<b>Draining Solution Tank</b> .....	22
<b>Safety Labels</b> .....	6	<b>Flushing Recovery Tank</b> .....	23
<b>LCD Screen</b> .....	7	<b>Clean Drain Saver</b> .....	24
<b>Operation Controls</b> .....	8	<b>Clean Cylindrical Hopper</b> .....	25
<b>Touch Screen (Optional)</b> .....	9	<b>Clean Vac Box System</b> .....	26
<b>Touch Screen Symbols (Optional)</b> .....	10	<b>Remove Disk Brushes</b> .....	27
<b>Touch Screen Zone Operation (Optional)</b> .....	11	<b>Remove Cylindrical Brushes</b> .....	28
<b>Touch Screen Zone Programming (Optional)</b> .....	12	<b>Charge Batteries</b> .....	29
<b>Battery Setup</b> .....	13	<b>Battery Chargers</b> .....	30
<b>Remove Squeegee</b> .....	14	<b>Common Wear Parts</b> .....	31
<b>Adjust Squeegee</b> .....	15	<b>Round Disk Brushes:</b> .....	31
<b>Remove From Battery Charger</b> .....	16	<b>Round Disk Pads:</b> .....	31
<b>Transportation - Forward</b> .....	17	<b>Cylindrical Brushes:</b> .....	31
<b>Transportation - Reverse</b> .....	18	<b>Squeegee Blade Kits &amp; Complete Squeegee</b>	
		<b>Assemblies:</b> .....	31
		<b>P&amp;G Controller Common Error Codes</b> .....	33



## SAFETY MESSAGES

You will see four kinds of safety reminders in this manual:

### **DANGER**

DANGER indicates a hazardous situation which, if not avoided, will result in death or serious injury.

### **WARNING**

WARNING indicates a potentially hazardous situation which, if not avoided, could result in death or serious injury.

### **CAUTION**

CAUTION indicates a potentially hazardous situation which, if not avoided, could result in minor or moderate injury or damage to this machine or nearby objects. CAUTION also can be used to alert against unsafe practices.

### **NOTICE**

NOTICE indicates information considered important, but not hazard-related. This safety message may be related to property damage or warranty warnings.

Your safety, and that of others, is very important. Operating this machine safely is an important responsibility.

### **DO NOT OPERATE THIS MACHINE:**

- Unless you are trained and authorized to do so by your RPS Authorized Local Distributor
- Unless you have read and understood this Operator's Manual
- On surfaces with greater than a 2% grade unless this machine is equipped with a functional parking brake
- On surfaces with greater than an 8% grade at any time
- On Loading Docks

### **WHEN OPERATING THIS MACHINE:**

- Remove loose objects from the floor that could be projected from the rotating Brushes
- Keep your hands and feet away from the rotating Brushes
- Do not operate this machine where flammable liquids, vapors, or dust are present
- Use caution when maneuvering

### **BEFORE LEAVING THE MACHINE:**

- Drain "clean" Solution & "dirty" Recovery solution into APPROVED drains
- Park the machine on a level surface
- Turn the machine off & remove key

### **BEFORE SERVICING THE MACHINE:**

- Disconnect the Batteries

### **DANGER**

Explosive hydrogen gas forms when Batteries are charging. An open flame or spark can cause this gas to explode. Serious personal injury or property damage could occur. Only charge the Batteries in this machine in a well ventilated area.

### **DANGER**

Flammable materials can cause an explosion or fire. Do not use flammable materials in Tank or pick up.

## **! WARNING**

The Batteries in this machine produce hazardous voltage which can cause electrical shock, burns and/or electrocution. Always disconnect Batteries before servicing this machine.

## **! WARNING**

When climbing or descending ramps, always drive machine forward. To avoid overturning the machine, Do not back down ramps. Do not drive across inclines. Do not turn while ascending or descending ramps. Overturning the machine can cause serious injury or death.

## **! WARNING**

Do not use water that exceeds 135°F / 57°C. If water is above said temperature, this will void the Tank Warranty.

## **! WARNING**

Do not park this machine on ramps or slopes. Always park this machine on a level, hard surface. Do not operate this machine outdoors or on uneven surfaces.

## **! WARNING**

The Batteries in this machine contain sulfuric acid, which causes burns to skin. If battery acid contacts clothing or skin, rinse the effected area with cold water immediately. If battery acid gets on your face or in your eyes, flush the area immediately with cold water and seek medical attention.

## **! WARNING**

To avoid electrical shock, do not operate this machine over electrical floor outlets.

## **! CAUTION**

To avoid damage to this machine, use only cleaning solutions and replacement parts recommended by the manufacturer.

## **! CAUTION**

Do not operate this machine if any parts have been damaged or removed.

## **! WARNING**

Dress safely. Do not wear rings or metal wrist watches when servicing this machine, as they can cause an electrical short circuit which can cause serious burns.

## **! WARNING**

Do not remove, paint over or destroy warning decals. If warning decals become damaged, call 1-262-681-3583 for free replacements.

## **! WARNING**

Dress safely. Do not wear a neck tie, scarf, or any loose or dangling clothing while operating this machine. Loose or dangling clothing or neck-wear can tangle in rotating parts, causing serious injury or death.

## **! WARNING**

Always turn off this machine before leaving it unattended. Do not allow untrained persons to operate this machine.

## **! WARNING**

NO RIDERS. Do not carry passengers on this machine. Do not use this machine as a stepladder or work platform.

## **! WARNING**

Understand the dynamic braking system before you operate the machine on ramps. Machine may coast.

## **! WARNING**

Before you service a Battery, always wear face protection, protective gloves and protective clothing. Battery acid or battery explosion can cause serious injuries.

## **! CAUTION**

Always use the automatic battery charger provided by the manufacturer of this machine to charge the Batteries of this machine. It is designed to charge the Batteries at the appropriate rate. If you must use a different charger, disconnect the Batteries before charging to avoid damage to the electronic speed controller.

## **! CAUTION**

To avoid damage to the electronic control components of this machine, Do not store this machine outdoors. Do not pressure wash this machine.



## SAFETY LABELS

Read and obey all Safety Labels on your MICRO-HD Floor Scrubber. If you have questions about these labels, ask your supervisor.

These images indicate where on the MICRO-HD Safety Labels are located. If ever the labels become illegible, worn off, or torn, promptly report it to your supervisor and replace it.

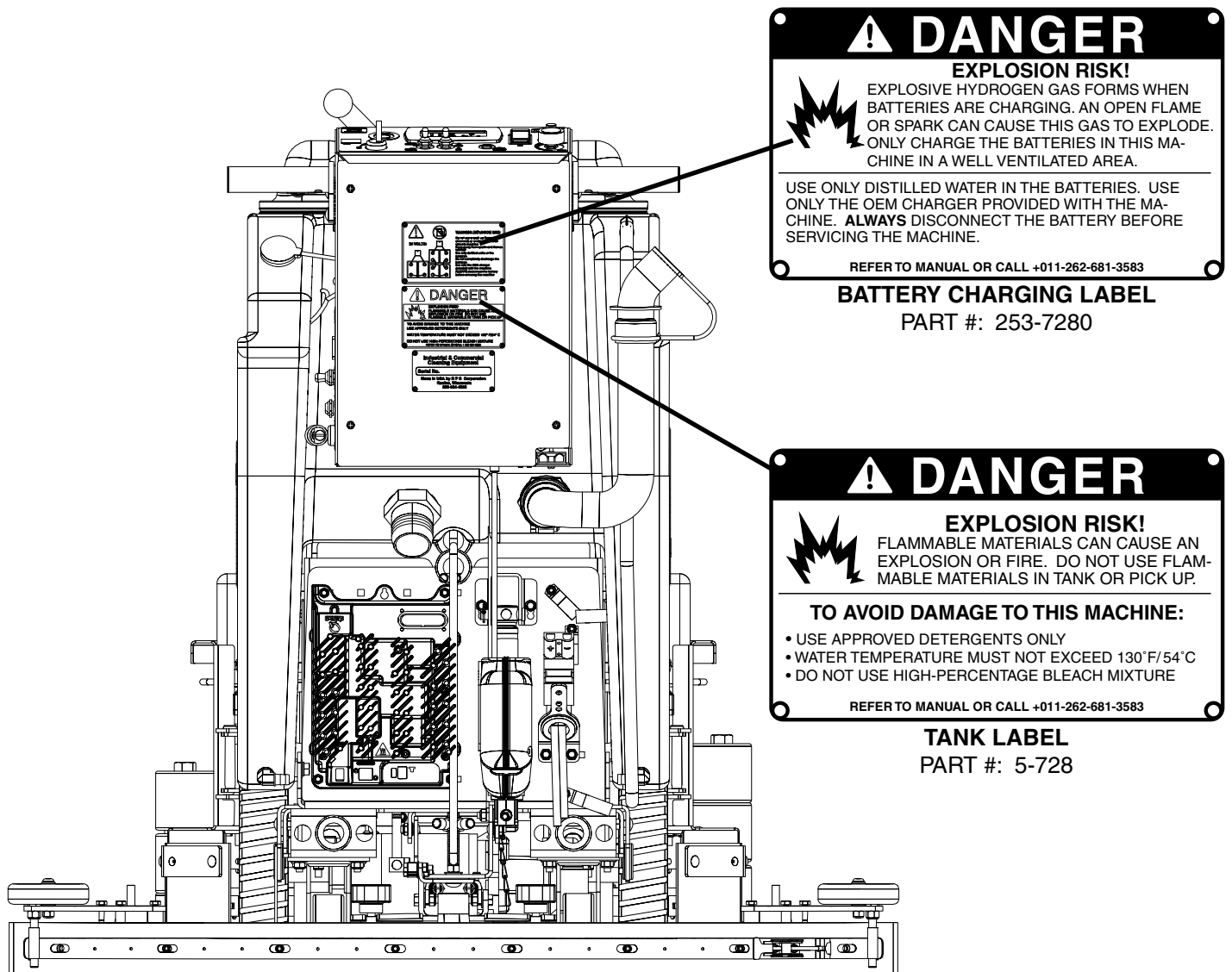

## LCD SCREEN



SCREEN #1 (OPERATOR)

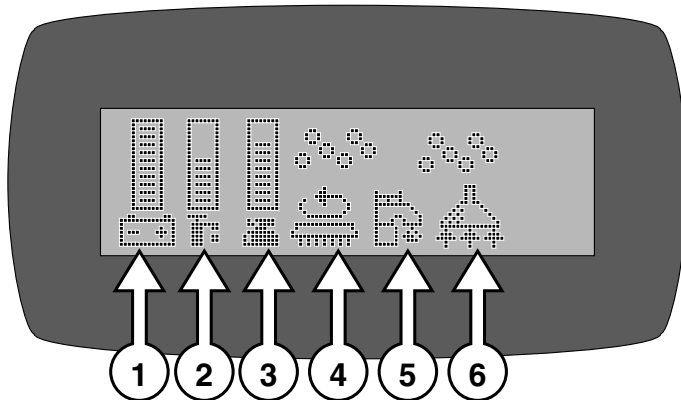

SCREEN #2 (MAINTENANCE)

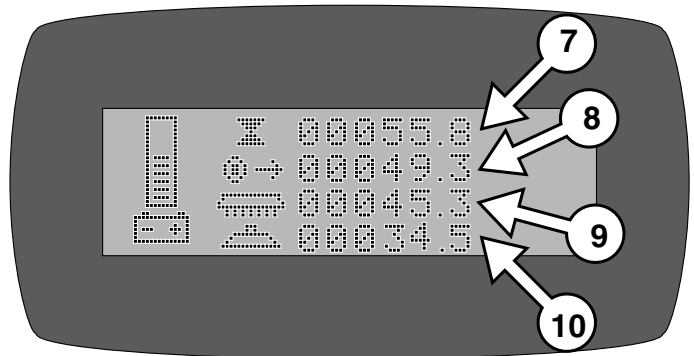

SCREEN #3 (WITH ERROR CODE)

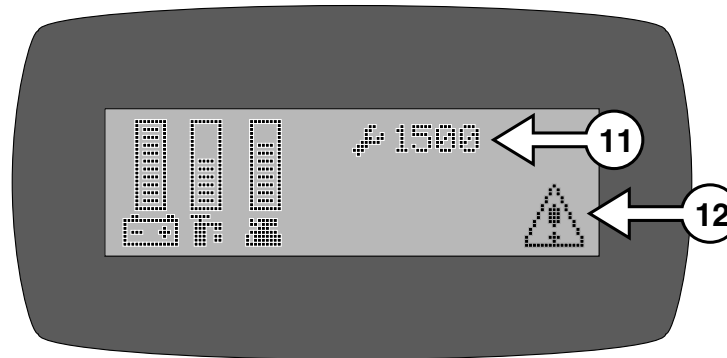

**\*\* USE GREEN MENU SELECTION BUTTON ON CONTROL PANEL TO CHANGE SCREENS \*\***

1. **BATTERY LEVEL INDICATOR** - Indicates the energy level remaining in the Batteries (*Shown on all menu displays*)
2. **SOLUTION OUTPUT INDICATOR** - Indicates the gallons per minute (*GPM*) 0 - 1.0
3. **SCRUBDECK DOWN PRESSURE INDICATOR** - Sets the down pressure on the Brushes / Pads
4. **SCRUB MOTORS ON** - Indicates the Brush Motors are in operation
5. **SOLUTION ON** - Indicates the solution flow is *ON*
6. **VACUUM ON** - Indicates the Vacuum is *ON*
7. **KEY SWITCH HOUR METER** - Indicates total hours the machine has had keyswitch *ON*
8. **TRANSPORT HOUR METER** - Indicates total hours the drive system has been in operation
9. **SCRUB BRUSH HOUR METER** - Indicates total hours the brush motors have been in operation
10. **VACUUM HOUR METER** - Indicates total hours the vacuum motor has been used
11. **DIAGNOSTIC CODE** - Displays diagnostic code which helps troubleshoot issues
12. **ERROR WARNING SYMBOL** - Indicates when there has been a diagnostic code error



OPERATION CONTROLS

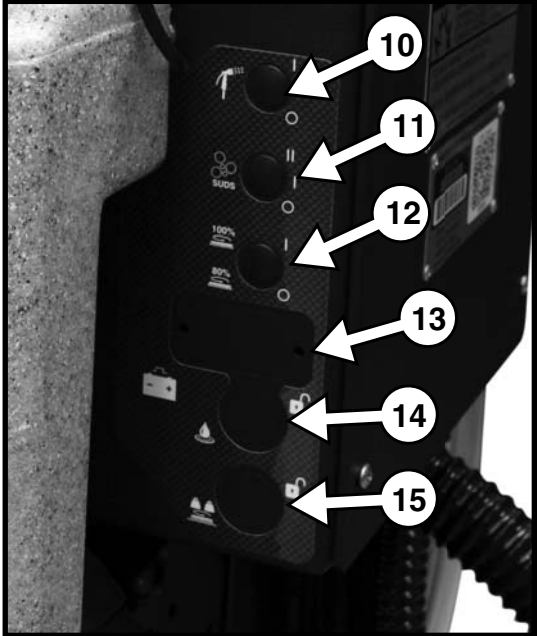
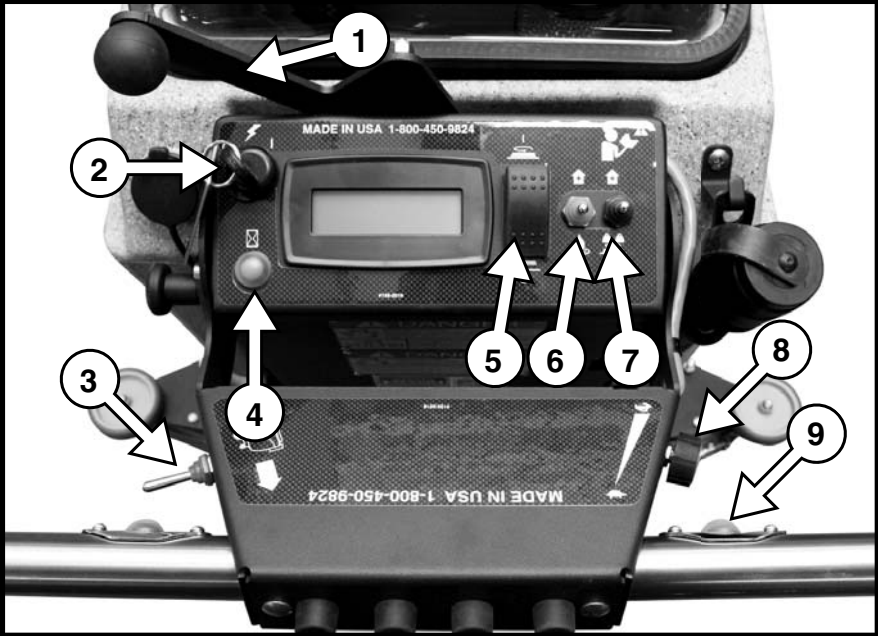

<p>1.</p>	<p>2.</p>	<p>3.</p>
<p>4.</p>	<p>5.</p>	<p>6.</p>
<p>7.</p>	<p>8.</p>	<p>9.</p>
<p>10.</p>	<p>11.</p>	<p>12.</p>
<p>13.</p>	<p>14.</p>	<p>15.</p>



# TOUCH SCREEN (OPTIONAL)

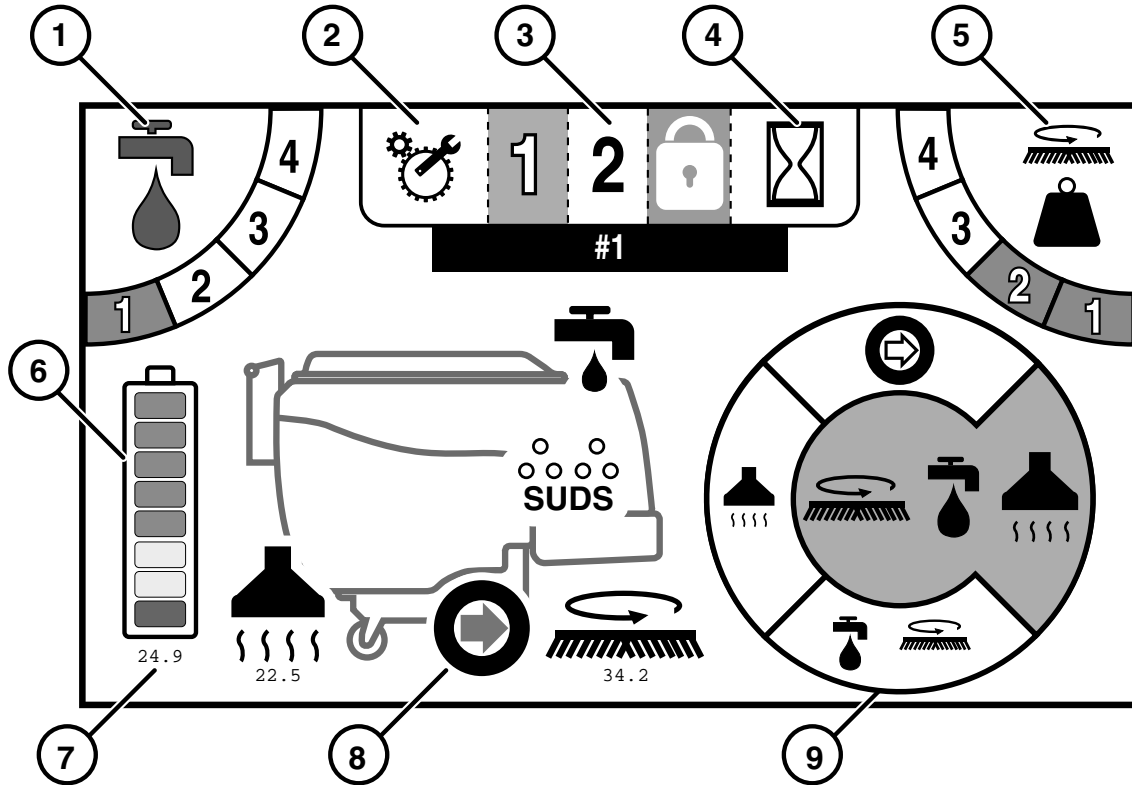
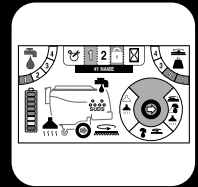

1. **SOLUTION OUTPUT** - Indicates the level of solution that is being dispensed when in operation
2. **TECHNICAL / MANAGER SETUP** - Access 'Error Code History' and Manager Programming
3. **PROGRAMMED ZONES** - Switch between preset solution and downpressure settings for varying applications
4. **HOUR METERS** - Displays all of the hour meters of the machine: Key Switch, Transport, Scrub Motors, and Vacuum Motor
5. **DOWN PRESSURE OUTPUT** - Indicates the level of downpressure that is being applied to the floor surface
6. **BATTERY GAUGE** - Indicates the level of battery charge available
7. **ACTIVE VOLT & AMP DRAW** - Indicates the live DC Volts (under battery gauge) and Amp draw (under systems) when machine is running
8. **ACTIVE SYSTEM MACHINE DISPLAY** - Indicates which systems of the equipment currently has power
9. **OPERATION MODE SELECTOR** - Cycle through and select which operation mode you would like to work in

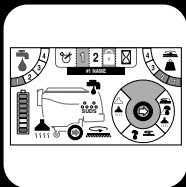

# TOUCH SCREEN SYMBOLS (OPTIONAL)

## Mode Selection

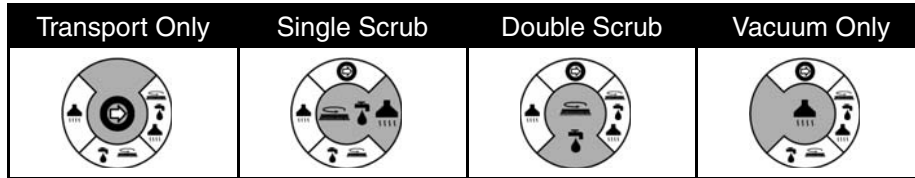

## Solution Setting



## Down Pressure Setting

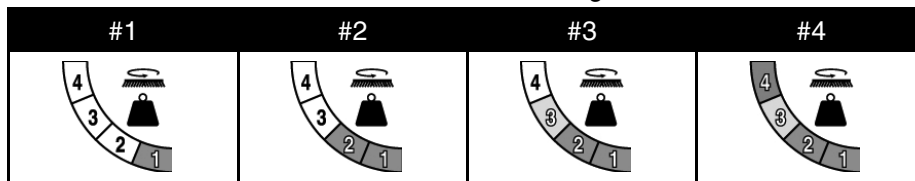

## Transport Motor



## Scrub Deck Motor(s)



## Solution Pump



## Vacuum Motor



## Setup



## Hour Meters



## Zone Lock

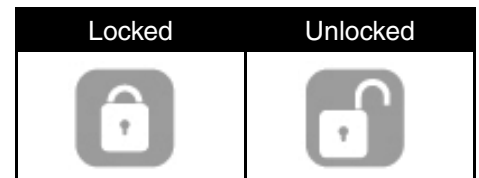

## TOUCH SCREEN ZONE OPERATION (OPTIONAL)

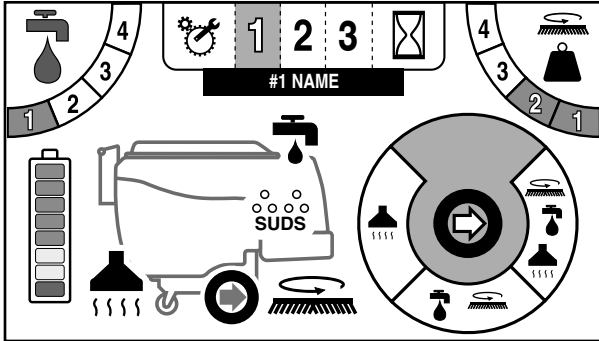

The touch screen is designed to be programmed to three specific zones. Each zone can be named and custom programmed or even disabled if not needed.

The zone you are working in is highlighted as indication. In Figure 1. the zone selected is Zone 1.

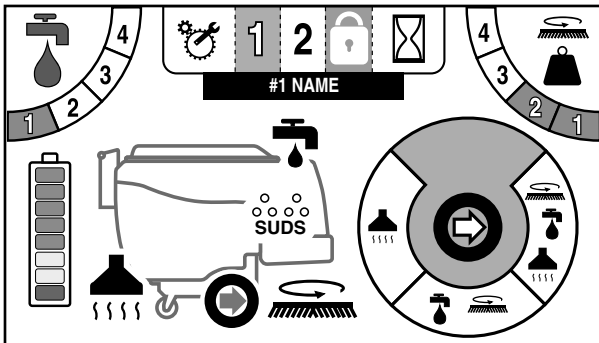
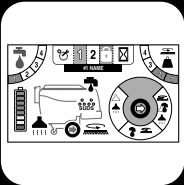
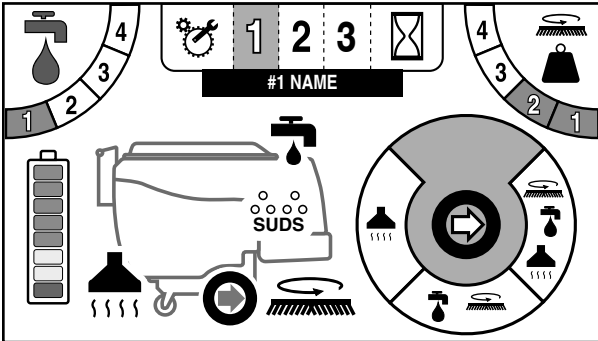

Figure 2. shows Zone 3 "locked out" by the indicator lock icon.



## TOUCH SCREEN ZONE PROGRAMMING (OPTIONAL)



To program the Zones, go to the Setup page by clicking on the Setup wrench and gear icon to the left of the Zone number buttons.

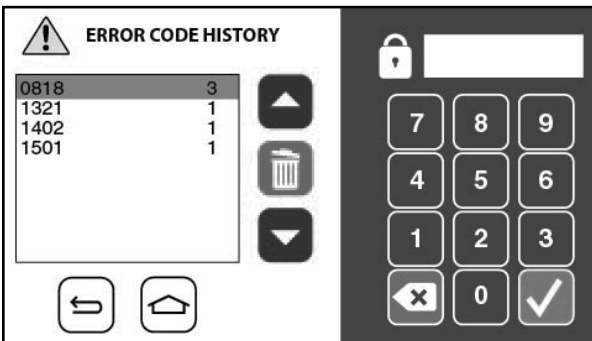

From here you will be prompted with a passcode screen. Enter the manager passcode to get access to setup.

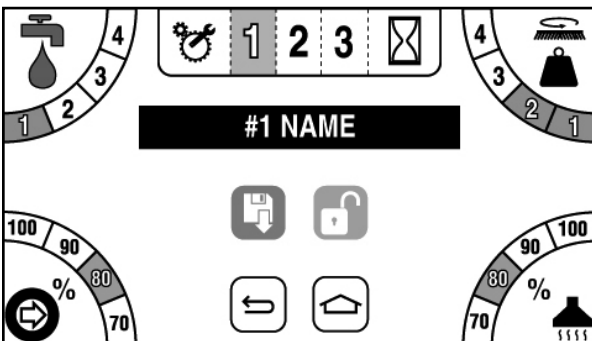

Once you have entered the password, you will see the Figure 3. screen where you can alter the name, solution output, down-pressure setting, scrubbing speed, and vacuum power.

Alternatively you can lock the Zone out from this screen.



To alter the name of a Zone, simply click on the black name box and a full keyboard will appear as Figure 4. shows.

# BATTERY SETUP

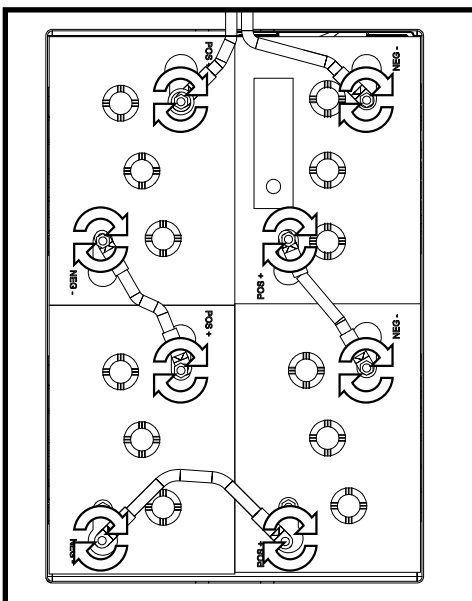
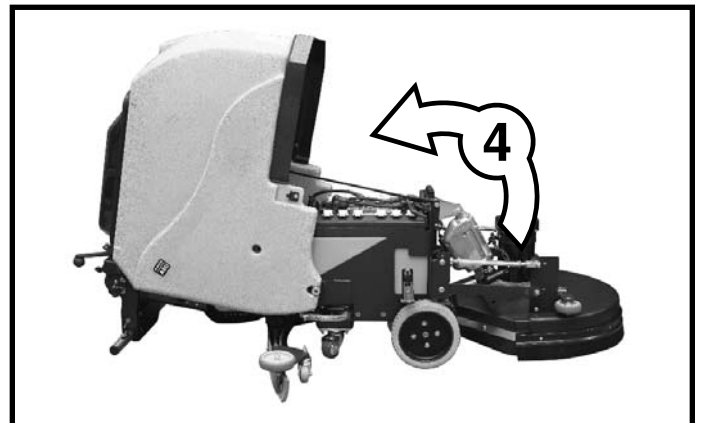
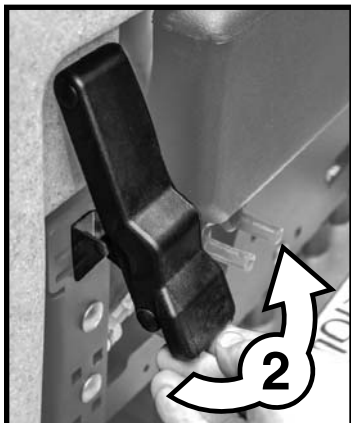
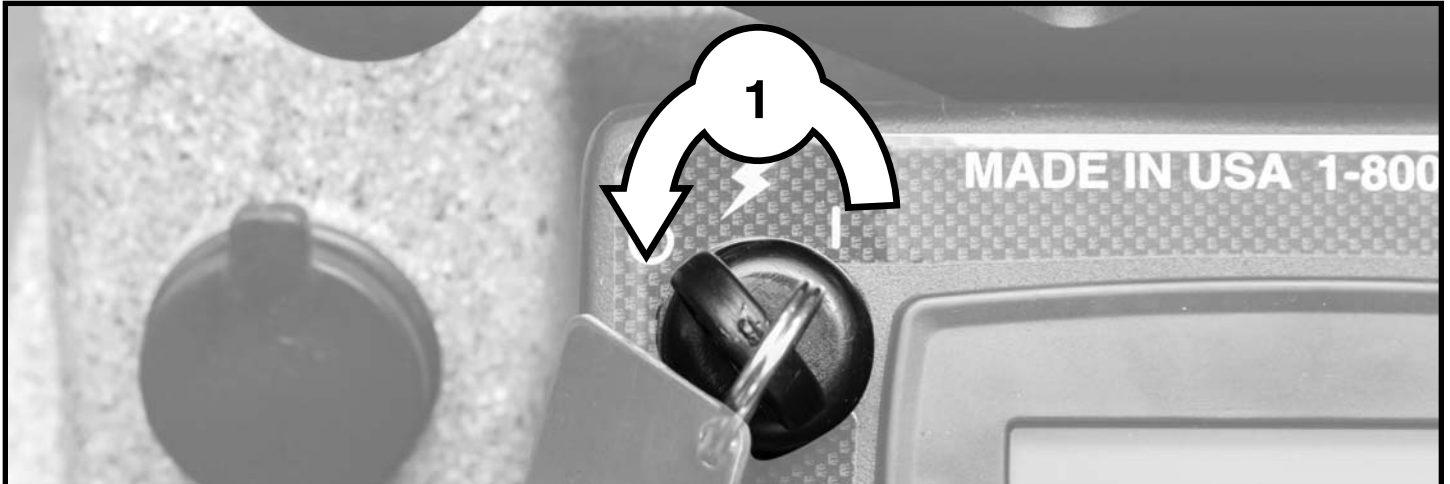
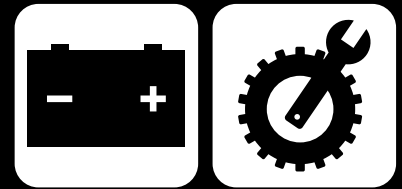

**24 VOLTS**

## NOTICE

Batteries are a possible environmental hazard. Consult your Battery supplier for safe disposal methods.

## NOTICE

Orientation of Batteries is critical for cables to reach. Ensure proper torque values when installing batteries. (Between 8 - 12 ft/lbs)



## REMOVE SQUEEGEE

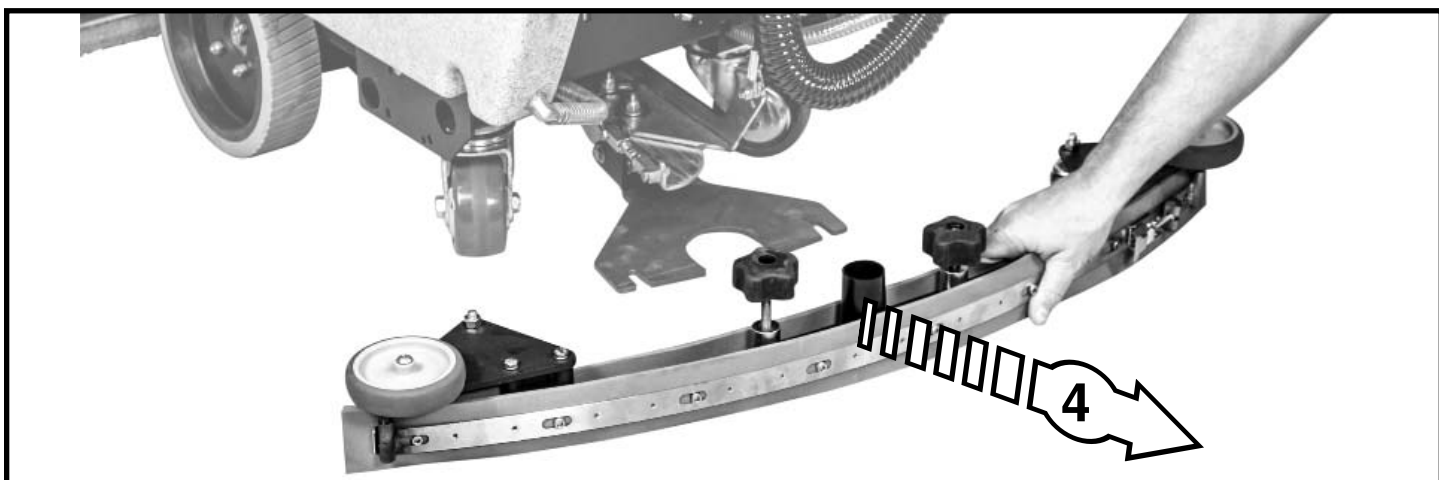
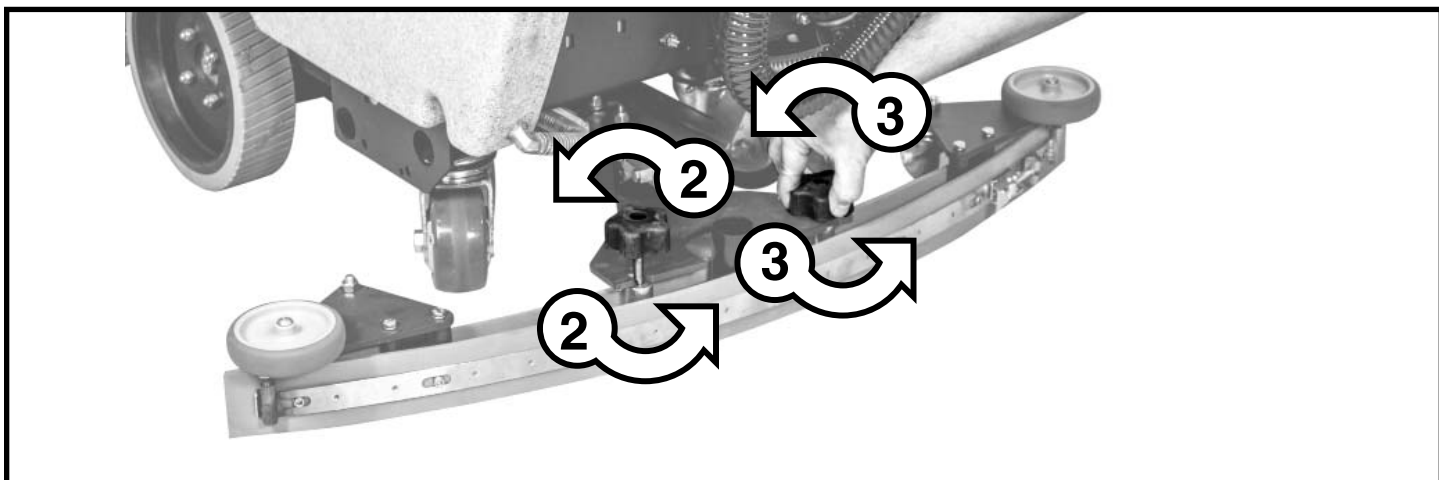
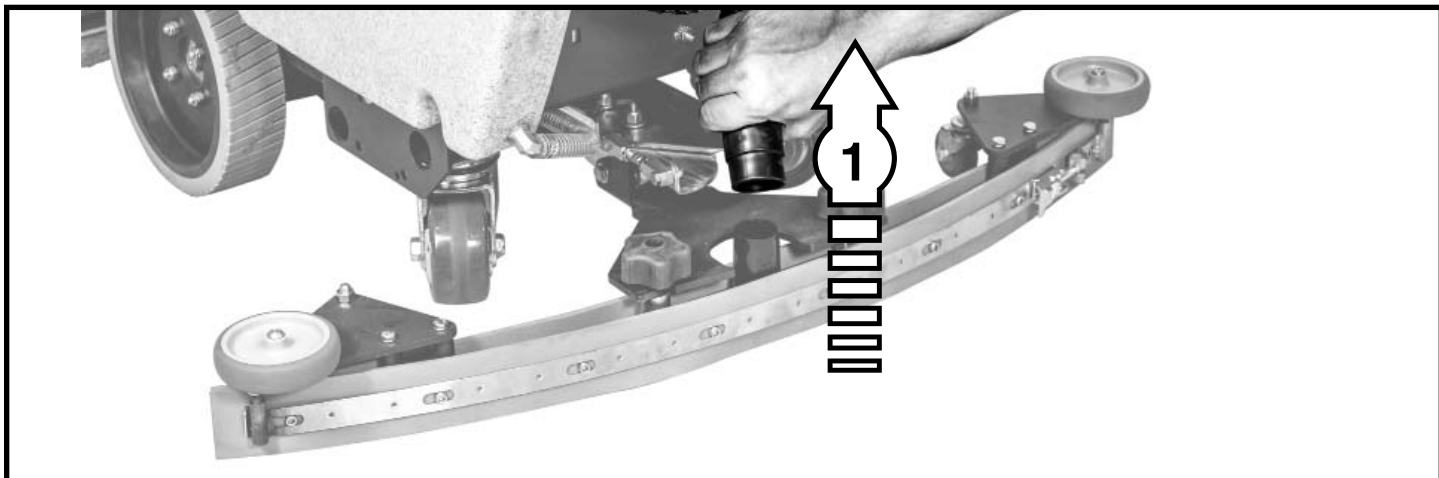

# ADJUST SQUEEGEE

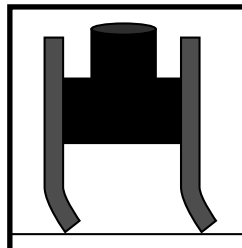
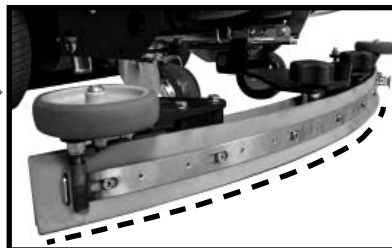
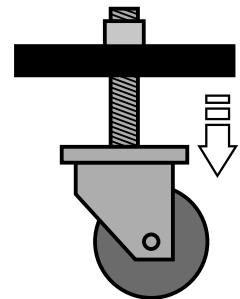
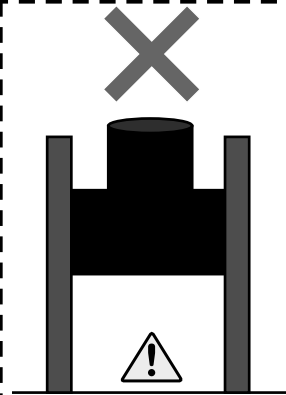
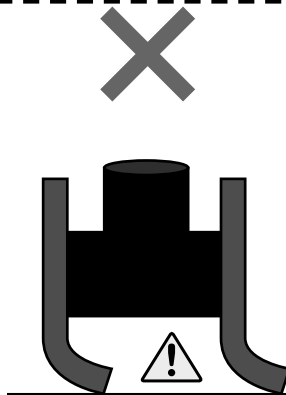
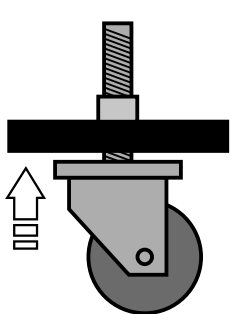
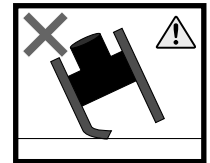
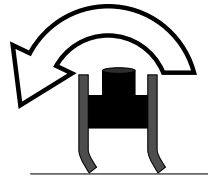
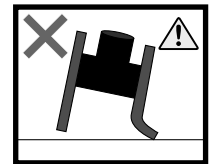
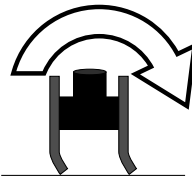
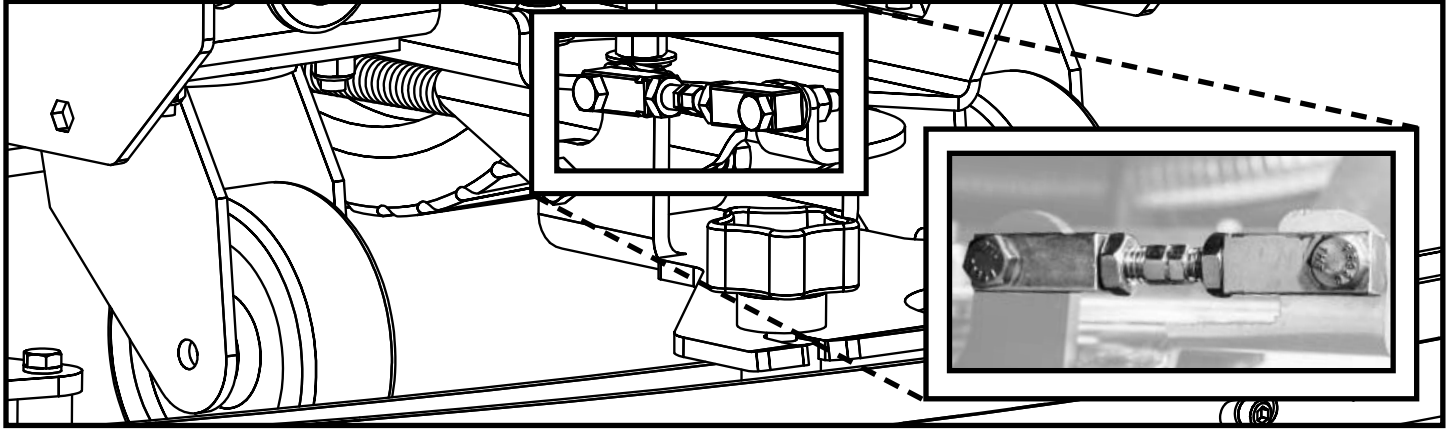
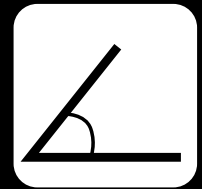
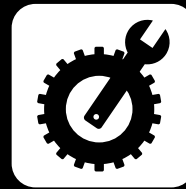

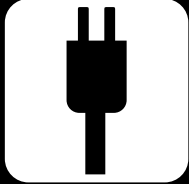
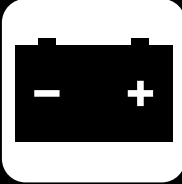

REMOVE FROM BATTERY CHARGER

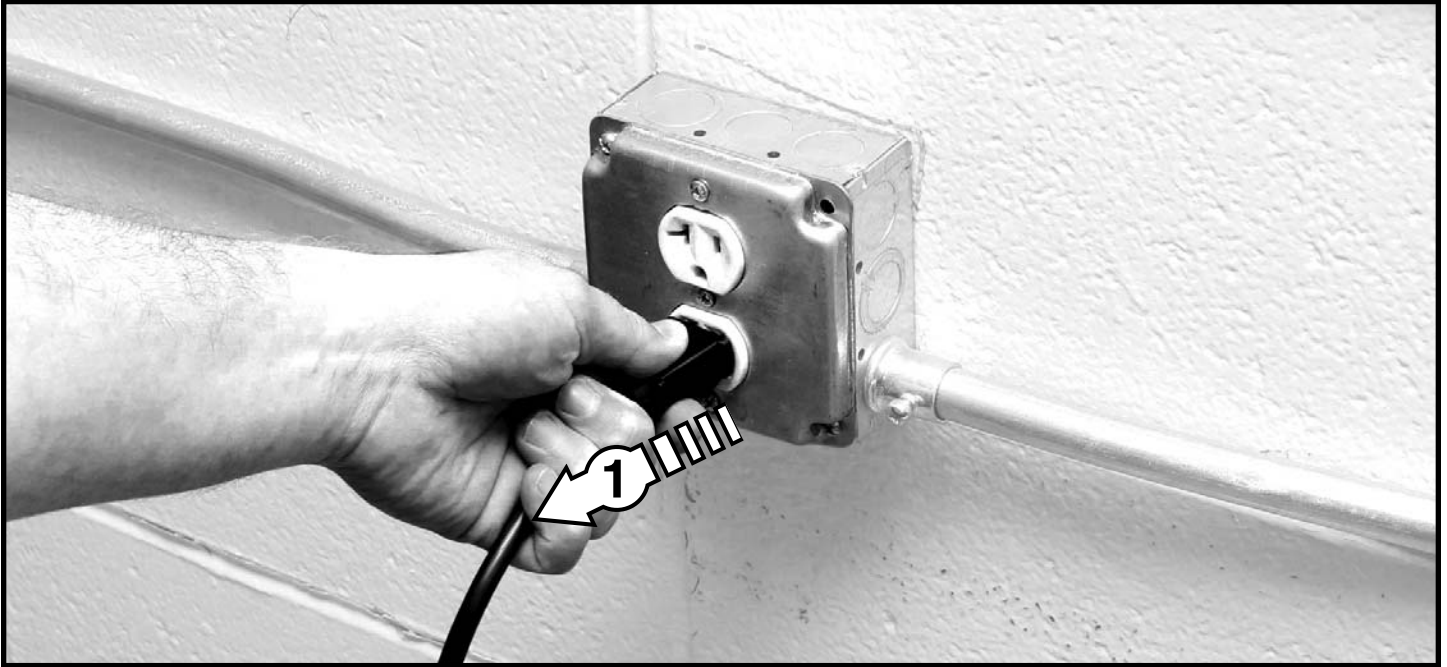

Please refer to OEM Charger Operating Instructions for more information.

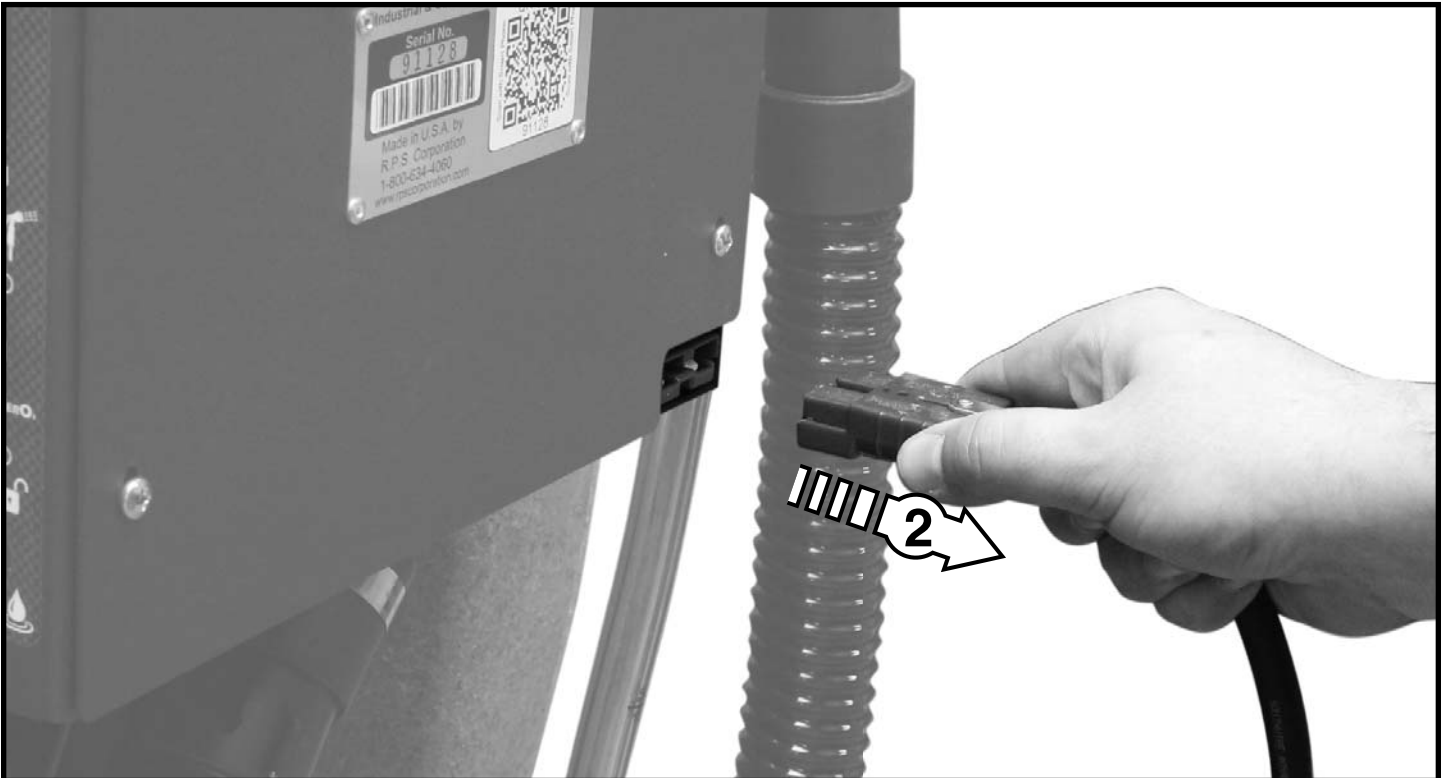



# TRANSPORTATION - FORWARD





TRANSPORTATION - REVERSE



## FILL SOLUTION TANK

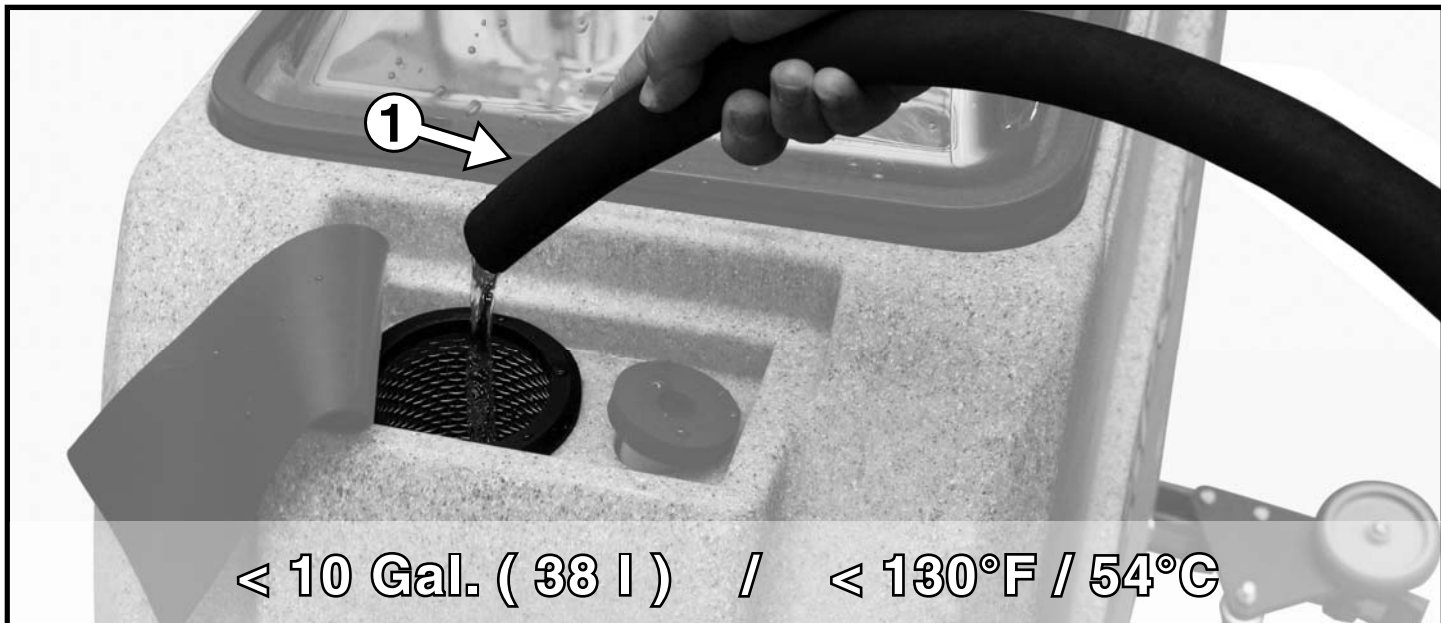

### **⚠ DANGER**

EXPLOSION RISK! Flammable materials can cause an explosion or fire. Do NOT use flammable materials in Tank or pick up.

### **⚠ CAUTION**

#### TO AVOID DAMAGE TO THIS MACHINE:

- Use APPROVED detergents only
- Water temperature must not exceed 130°F/54°C
- Do NOT use high-percentage Bleach mixture

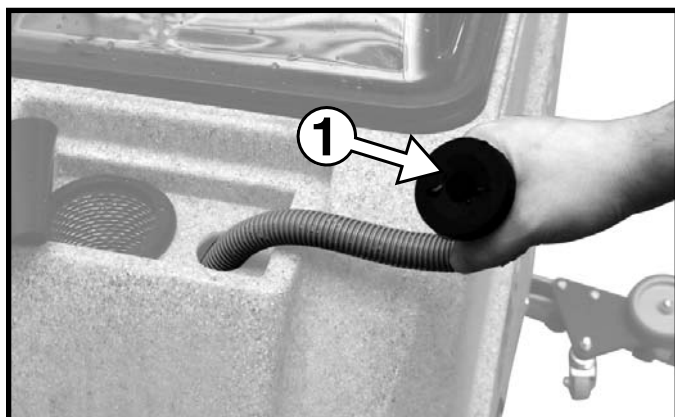



OPERATION - SCRUBBING

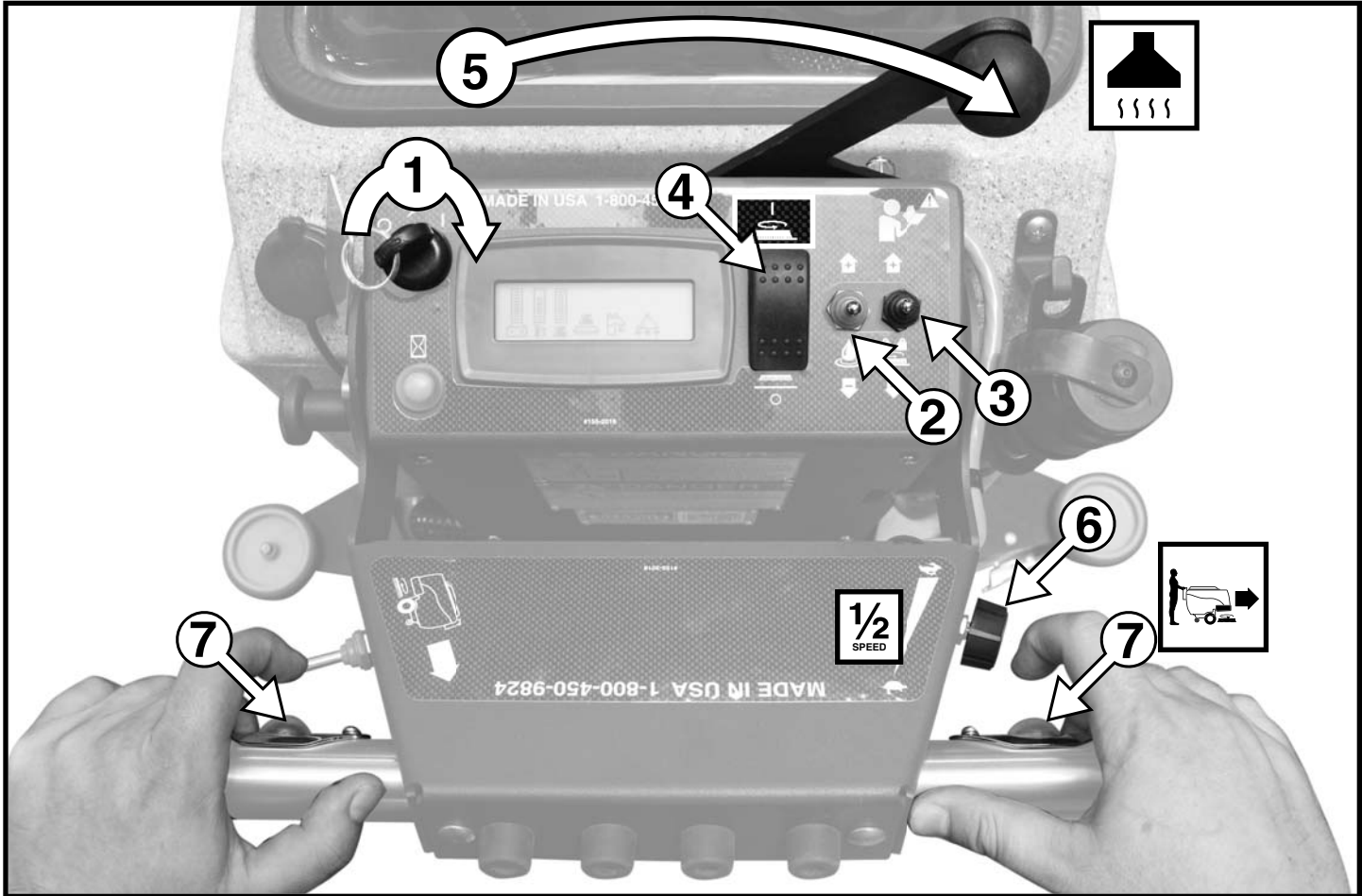

# DRAINING RECOVERY TANK

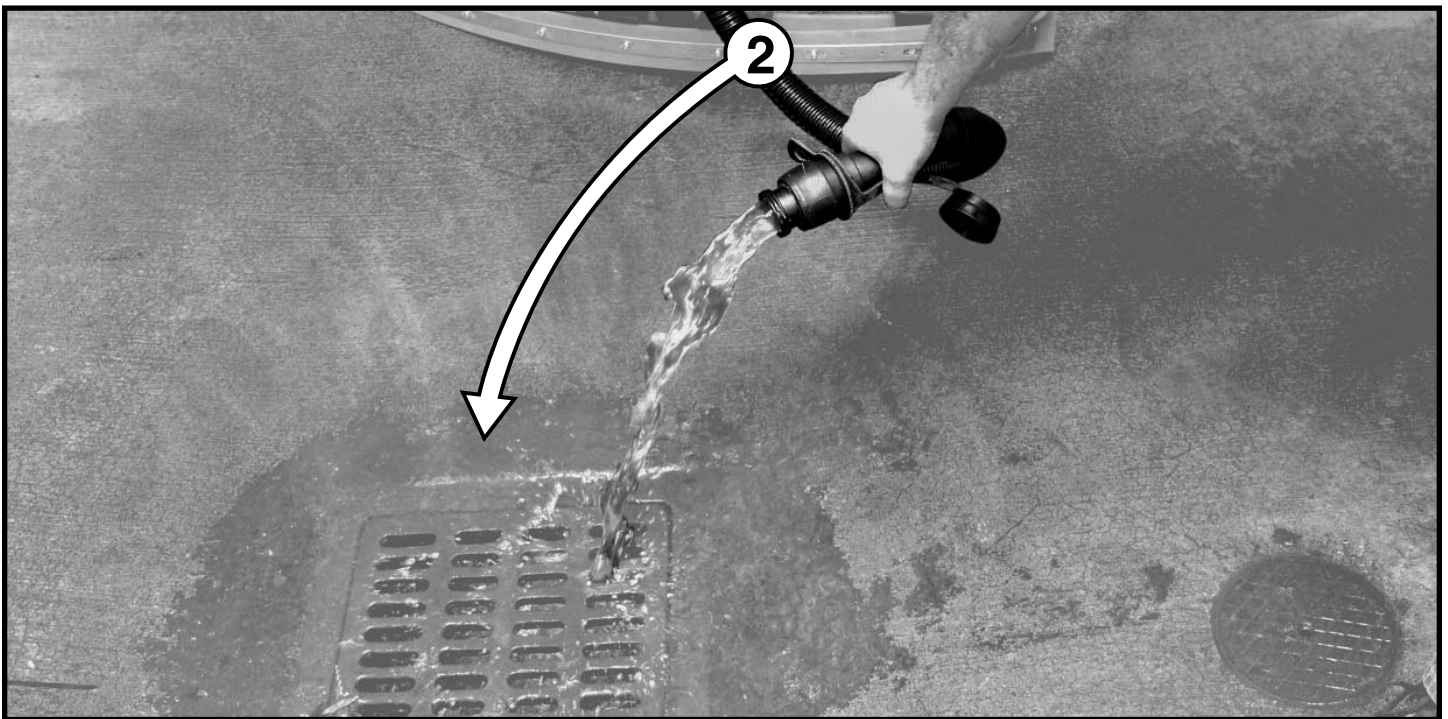
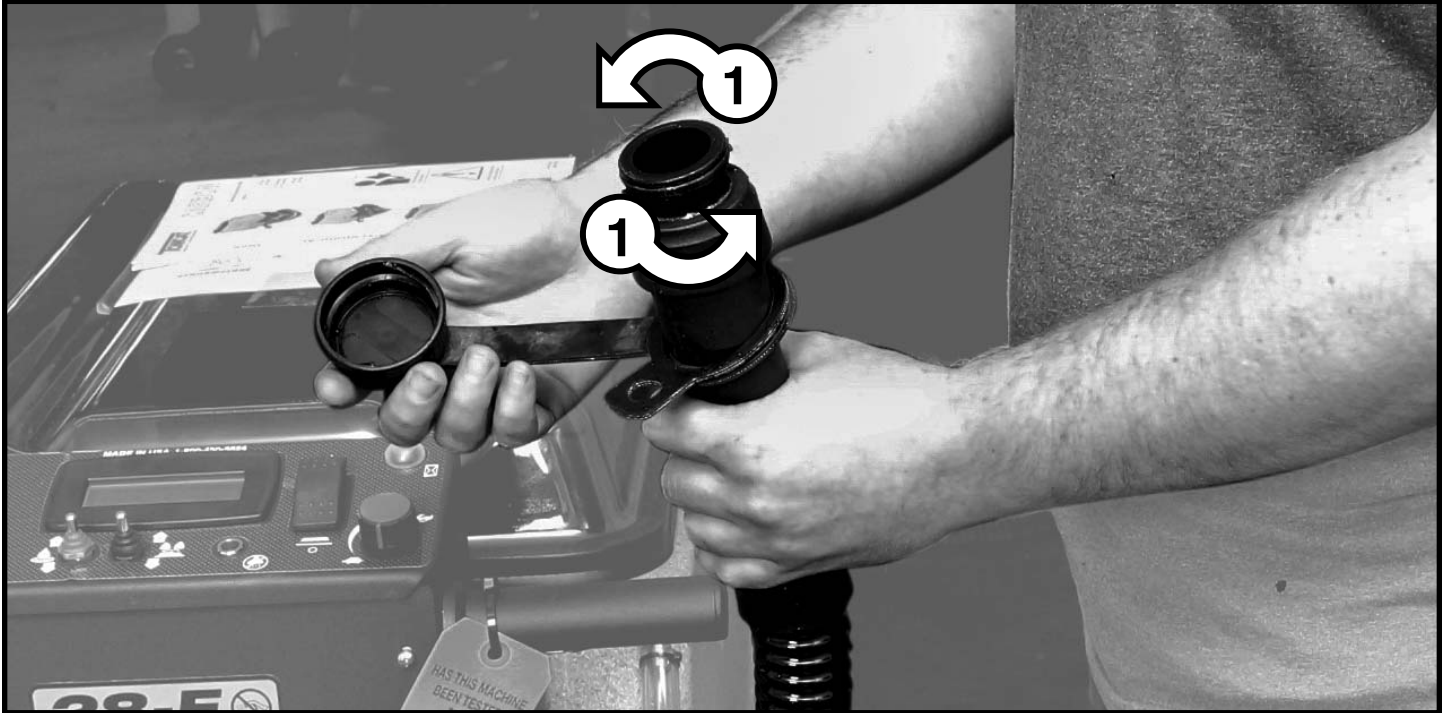



# DRAINING SOLUTION TANK

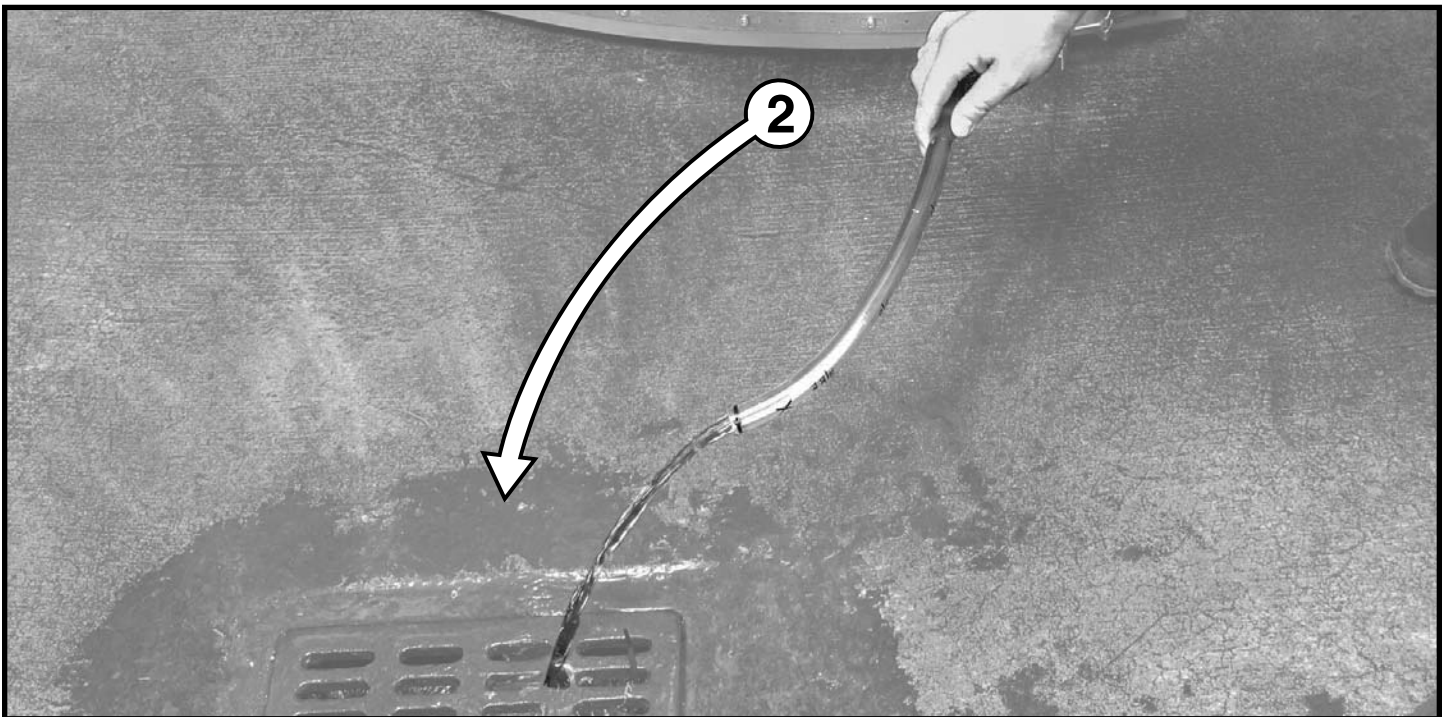

# FLUSHING RECOVERY TANK

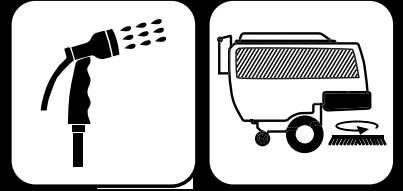



# CLEAN DRAIN SAVER

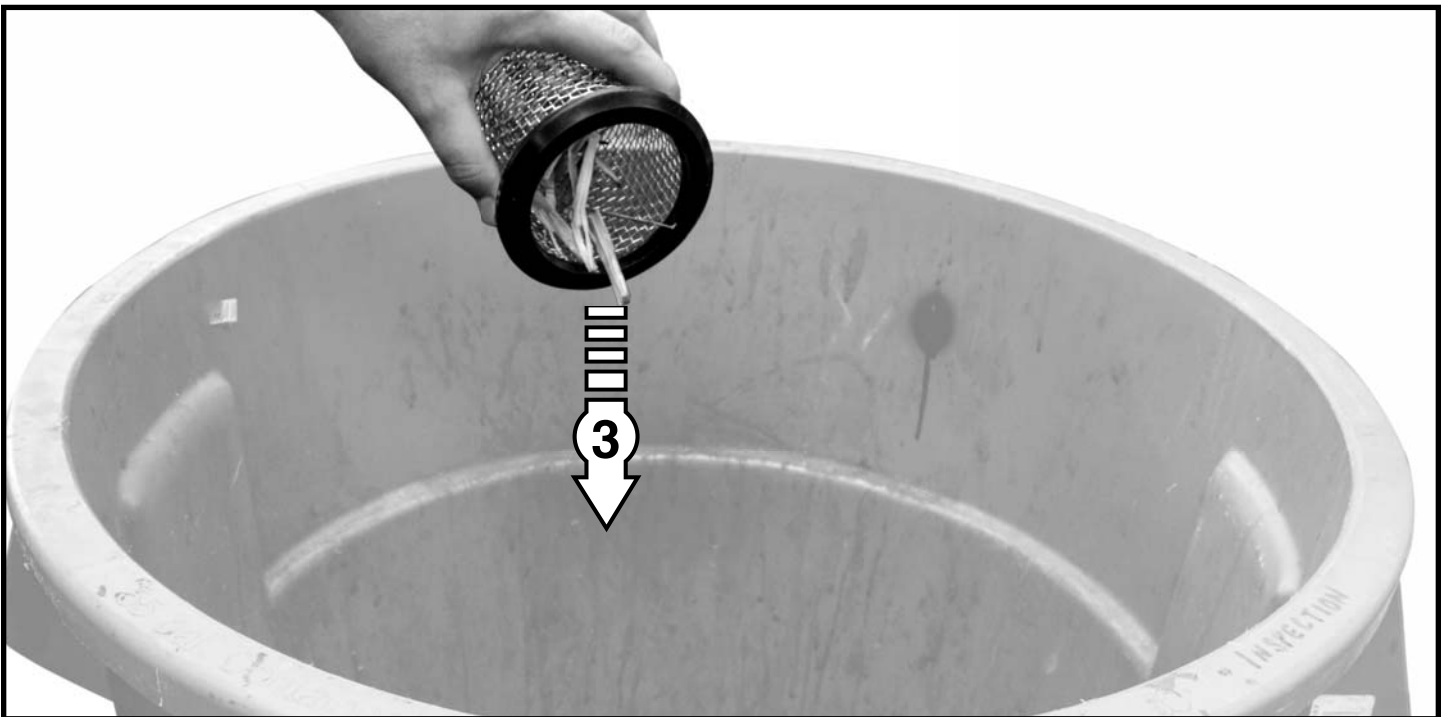



# CLEAN CYLINDRICAL HOPPER

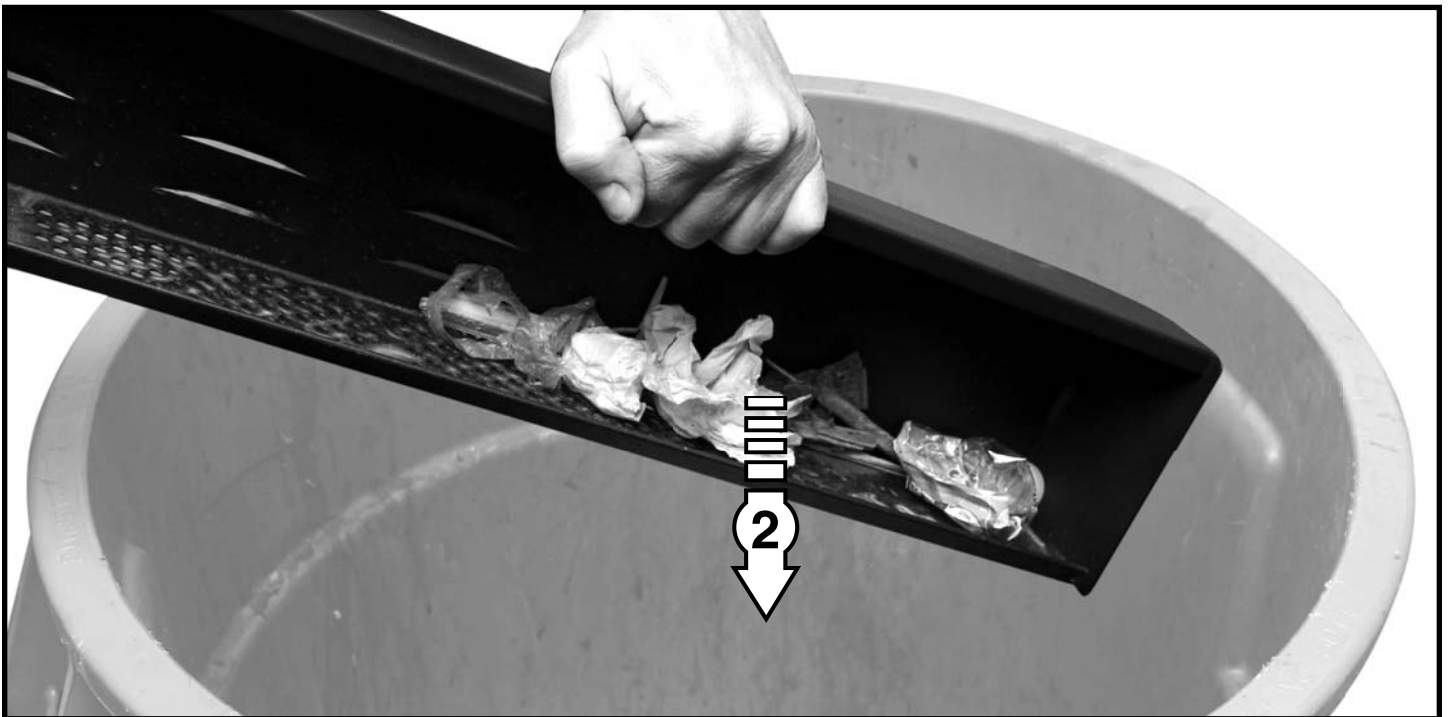
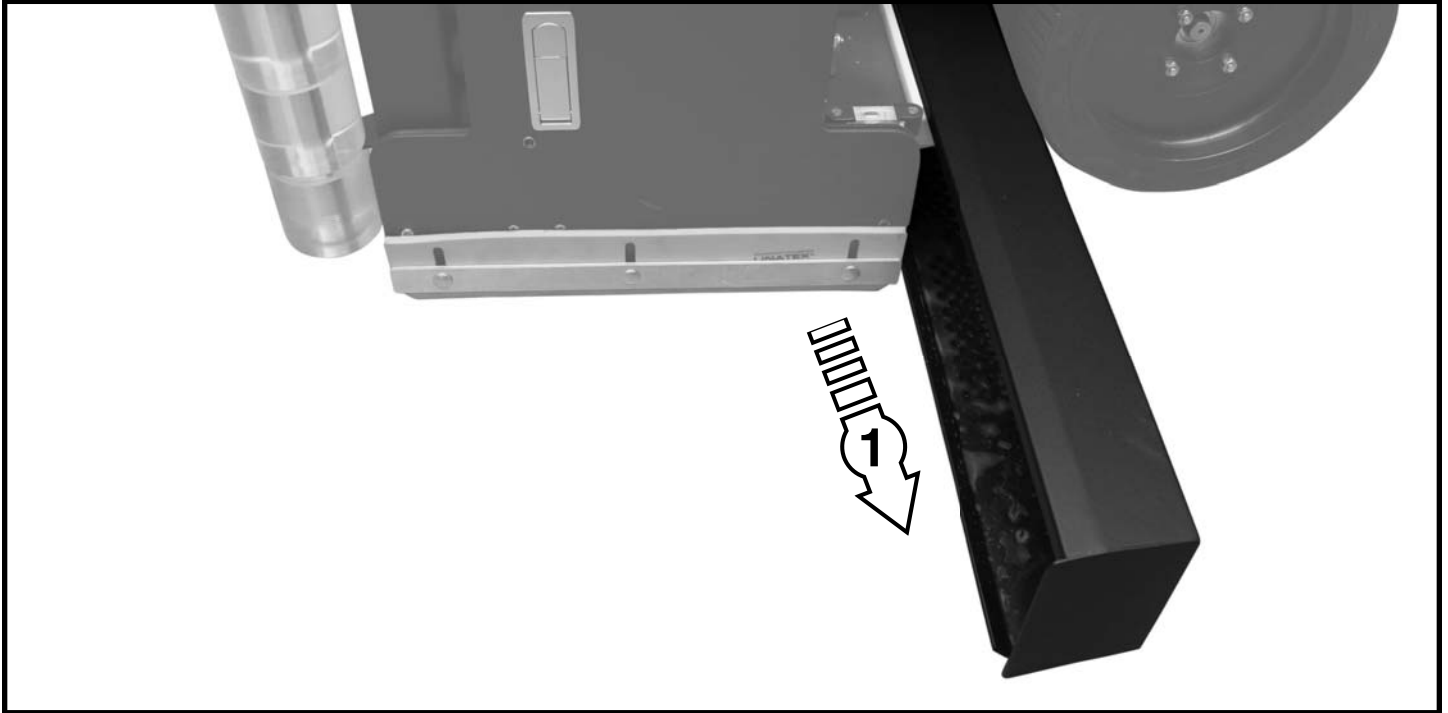

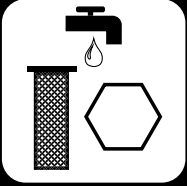

# CLEAN VAC BOX SYSTEM

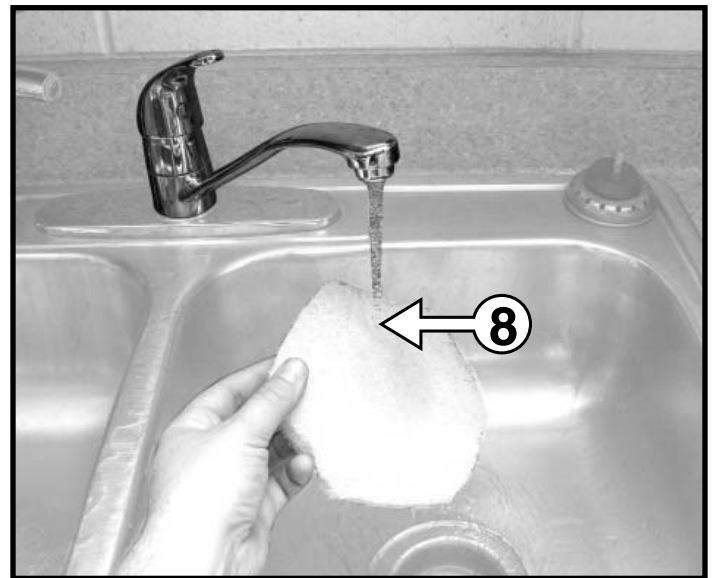
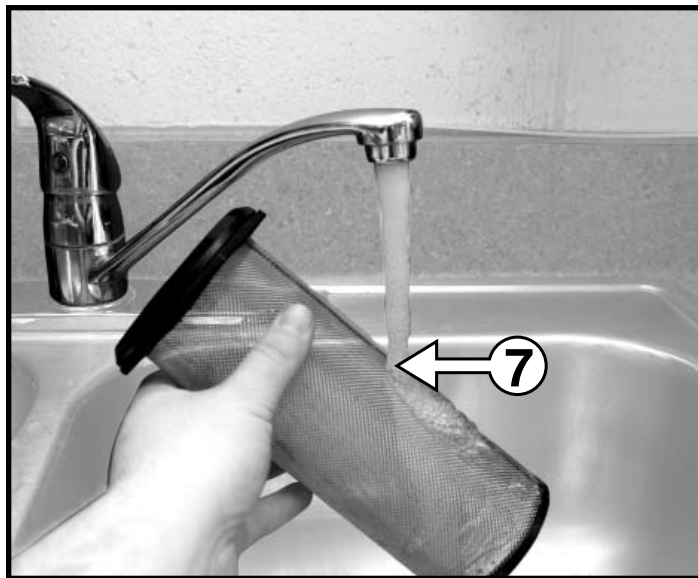
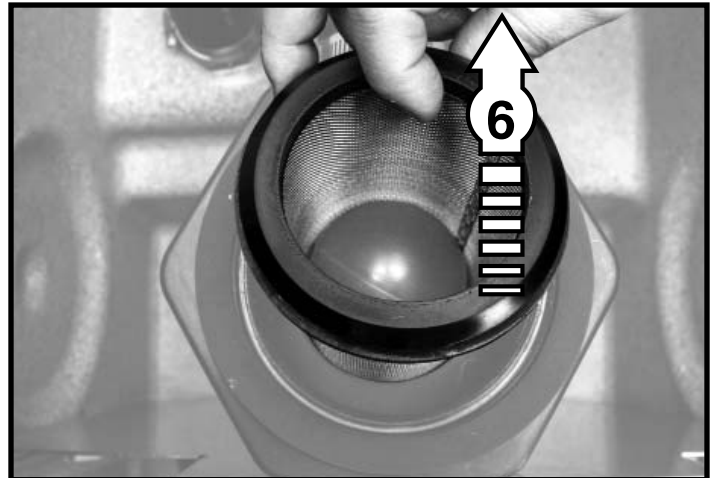
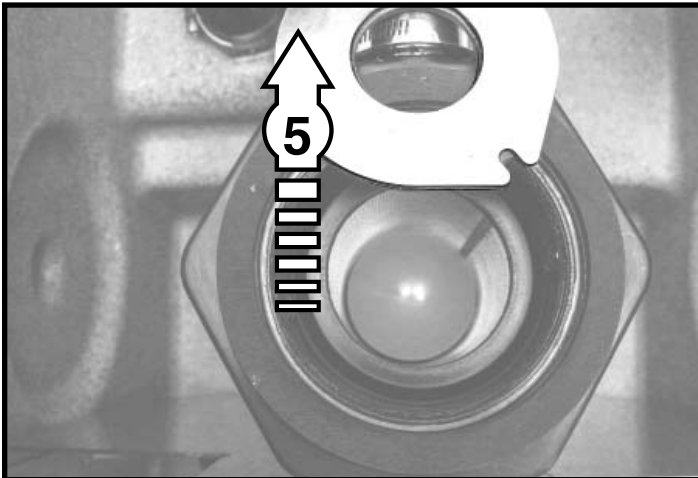
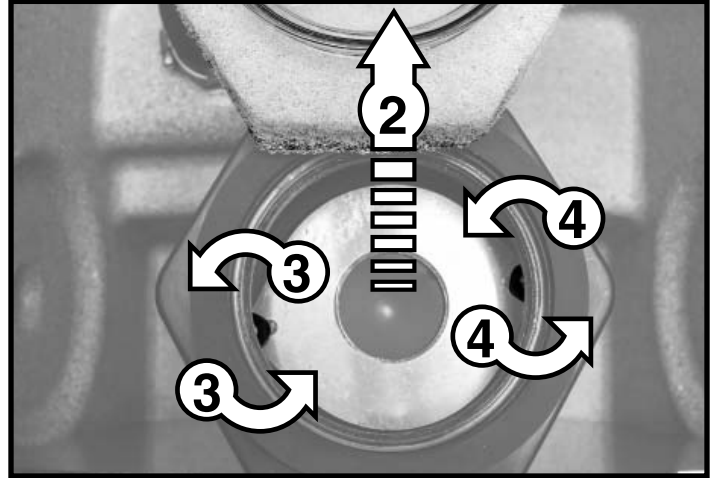
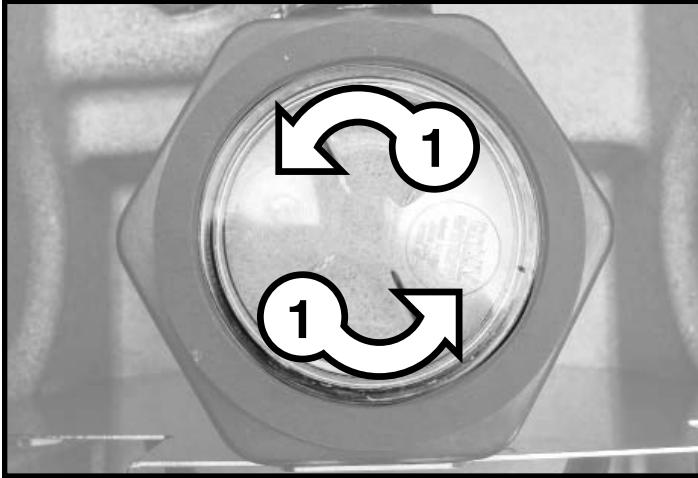

REMOVE DISK BRUSHES

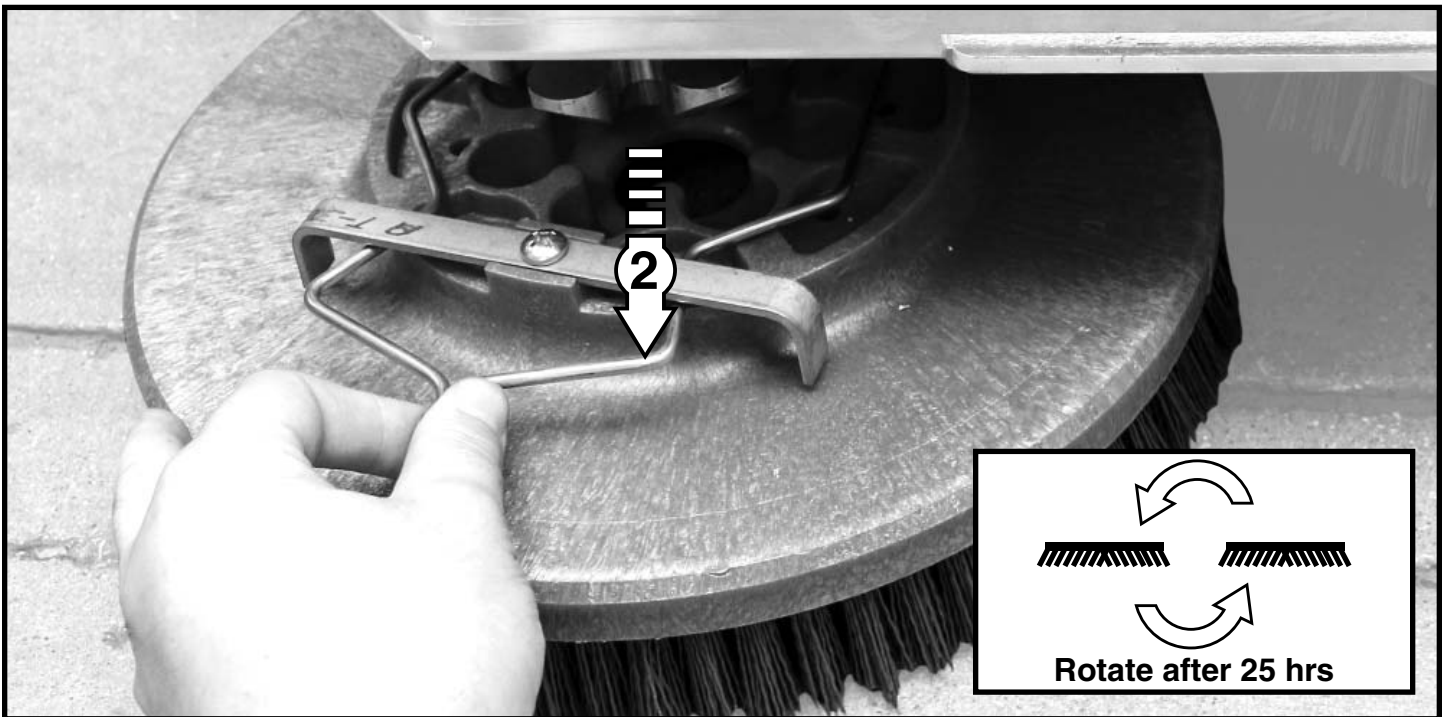
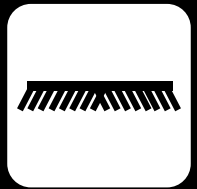

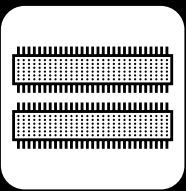

# REMOVE CYLINDRICAL BRUSHES

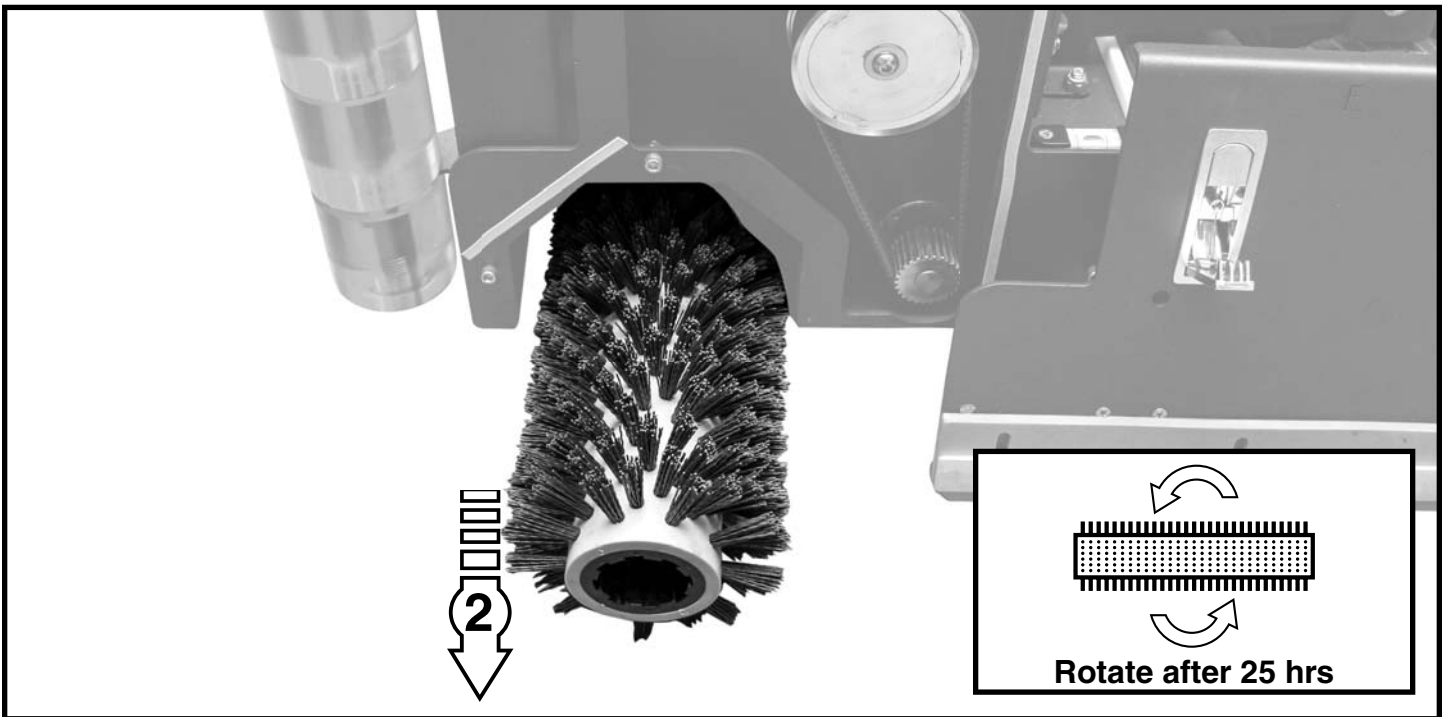
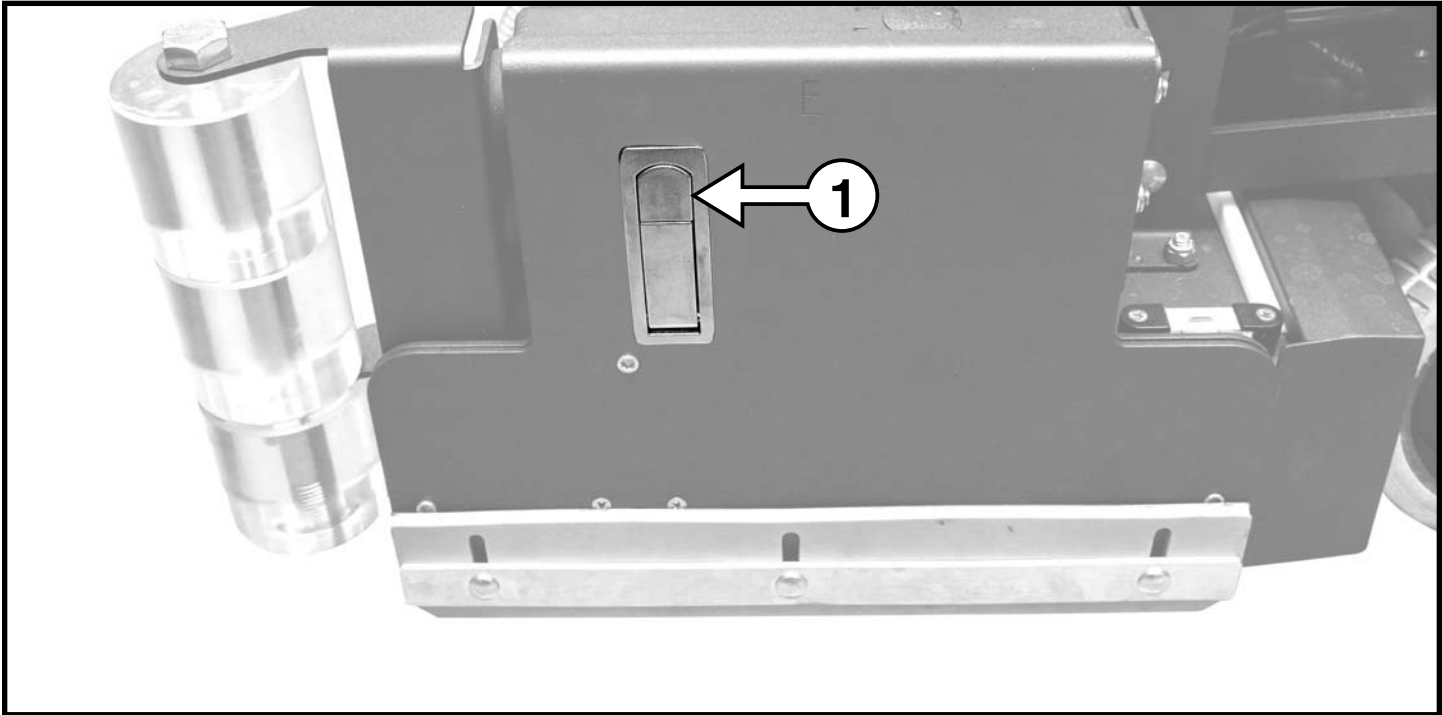

# CHARGE BATTERIES

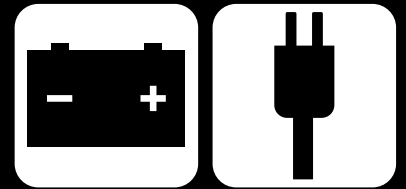

Please refer to OEM Charger Operating Instructions for more information.

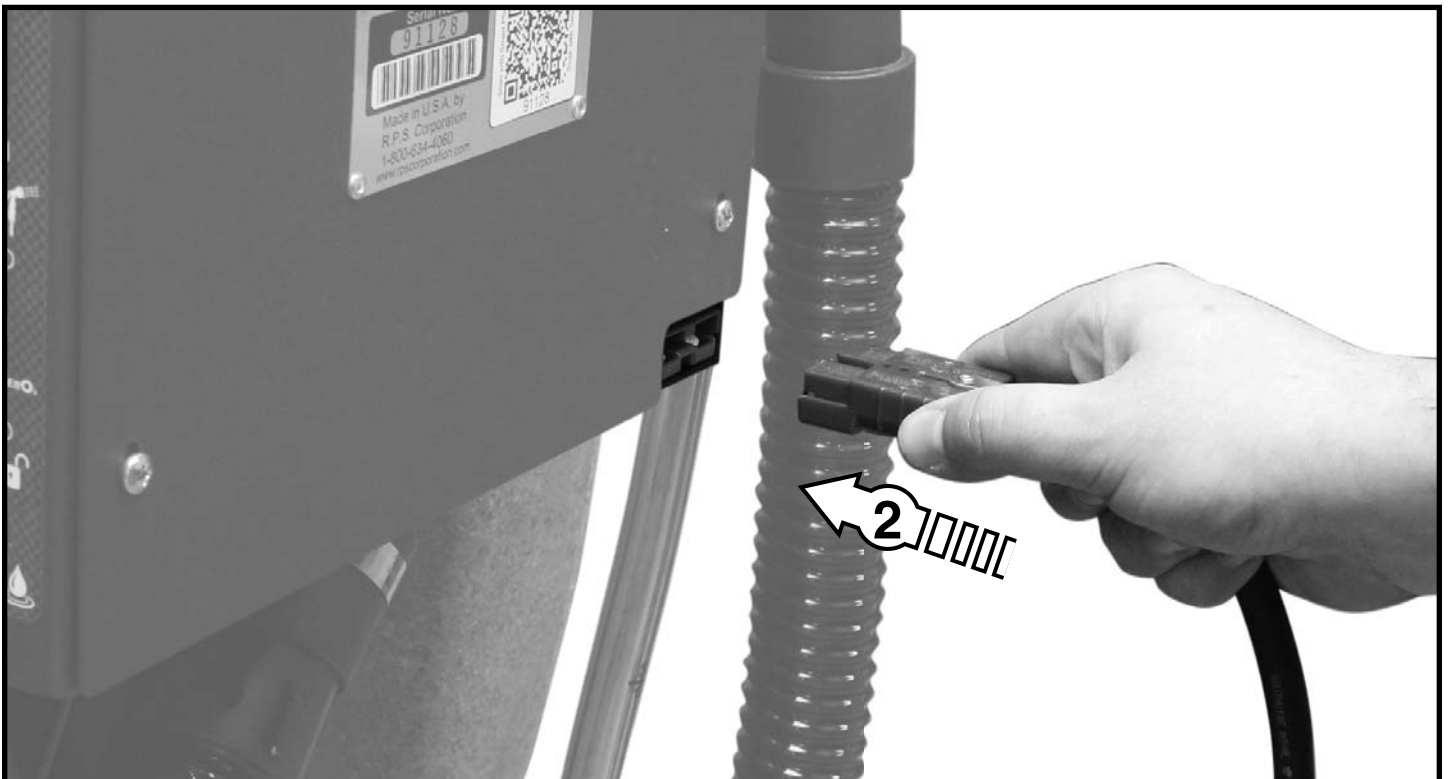

# BATTERY CHARGERS

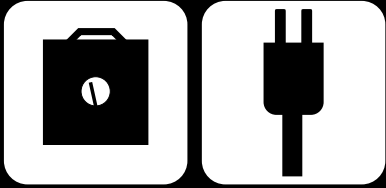

## Console / WET / Domestic Chargers:



**AC Power IN:** 120VAC / 60Hz  
**DC Power OUT:** 24VDC / 12A

Please refer to OEM Charger Operating Instructions for more information.



## Onboard / AGM / International Chargers:



**AC Power:** 80-270VAC / 50-60Hz  
**DC Power OUT:** 24VDC / 27A

Please refer to OEM Charger Operating Instructions for more information.



## COMMON WEAR PARTS

### ROUND DISK BRUSHES:

#### NOTICE

The ## in Disk Column Denotes Desk Pad Size: 13", 17" or 20"

BRUSHES	DISK	LEVEL
Super Grit	##-382SS	Very High
Tough Grit	##-382S	High
Midi Grit	##-382C	Medium
Light Grit	##-382PS	Moderate
Poly	##-382P	Light
Nylon	##-382N	Light
Tampico	##-382T	Light
Pad Driver	##-382D	
Diamond Driver	##-382DD	

### ROUND DISK PADS:

#### NOTICE

The ## in Disk Column Denotes Desk Pad Size: 13", 17" or 20"

DISK PADS	DISK	LEVEL	COLOR
Super Black	##-422BB	Very High	Black
Black	##-422B	High	Black
Brown	##-422BR	High	Brown
Green	##-422G	Medium	Green
Blue	##-422BL	Moderate	Blue
Red	##-422R	Moderate	Red
White	##-422W	Light	White

### CYLINDRICAL BRUSHES:

BRUSHES	MODEL 25" CYLINDRICAL	LEVEL
Tough Grit	236-697S	High
Midi Grit	236-697C	Medium
Light Grit	236-697PS	Moderate
Nylon	236-697N	Light
Tampico	236-697T	Light

### SQUEEGEE BLADE KITS & COMPLETE SQUEEGEE ASSEMBLIES:

SQUEEGEE SIZE	17" DISK DECKS	20" DISK DECKS	26" DISK DECKS	25" CYL. DECKS
36" Squeegee	Standard	Standard	Standard	Standard
42" Squeegee	Optional	Optional	Optional	Optional

SQUEEGEE SIZE	LINATEX BLADE KIT	GUM RUBBER BLADE KIT	URETHANE BLADE KIT	COMPLETE SQUEEGEE ASSEMBLIES
36" Squeegee	36-770L	36-770G	36-770U	36-7180
42" Squeegee	42-770L	42-770G	42-770U	42-7180

SQUEEGEE MATERIAL:	USED FOR:
LINATEX	Provides best wear and tear resistance. Not designed for use with harsh chemicals.
URETHANE	Provides best resistance when dealing with harsh chemicals, oils, fuels, etc.
GUM	Provides best drying performance on rough/grouted floor types by sealing over irregularities. Short life.

## NOTICE

Squeegee blade kits include (1) Rear Blade, (1) Front Blade, and (2) Caster Wheels with hardware.

## NOTICE

Squeegee Assemblies (complete) listed above all come with Linatex blades.

## NOTICE

Size is stamped into the top of the painted steel squeegee body on all squeegee's.

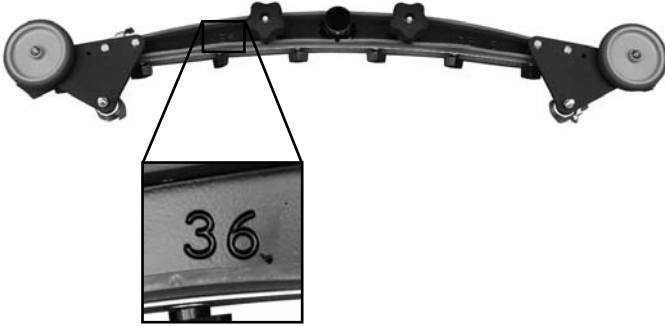



## P&G CONTROLLER COMMON ERROR CODES

Below are common diagnostic codes and some typical causes / remedies. If the information provided in the "Correction" section does not cure the code, seek technical support from your local authorized RPS Corporation distributor.

Diagnostic Code	Cause	Correction
1501	Parking brake is released or the parking brake coil circuit is open	Check to assure the parking brake is not manually released.
1507	Parking Brake Over Current	Parking brake coil is internally shorted or there is a problem with the wiring to the brake.
2C00-2C02	Battery voltage is low	Charge the batteries with OEM supplied charger.
2F01	Throttle is depressed during power on or a fault with the throttle system	Turn the machine off, assure that the throttle button(s) or throttle pedal are not depressed. Turn the machine back on and if the condition persists, seek technical support from your local authorized RPS distributor
3101	Brush / Vac Motor - Precharge Fault	This code can be caused by the scrub or vacuum motor(s) having moisture present or contaminated with debris.
3102	Traction Motor - Precharge Fault	This code can be caused by the traction motor having moisture present or being contaminated.
7600	Brush Motor Circuit Open	The controller is not seeing continuity on the brush motor circuit. This can be caused by the wiring to the scrub brush motor(s), corroded connections or a faulty motor.
7601-7603	Brush Motor Circuit Over Current	The brush motor output is exceeding its limit. With the scrubber turned off, check for entrapped debris around the brush driver(s) and assure the brushes turn freely.
7700	Vacuum Motor Circuit Open	The controller is not seeing continuity on the vacuum motor circuit. This can be caused by the wiring to the scrub brush motor(s), corroded connections or a faulty motor.
7701-7703	Vacuum Motor Circuit Over Current	The vacuum motor output is exceeding its limit. This can be caused by a faulty vacuum motor(s) or damaged vacuum motor wiring.
1E03	Charger / Seat Switch – Charger is plugged in or operator is not on the seat of ride on equipment.	On board charger is plugged into the wall outlet. Off board charger is plugged into charging port. The switch at the charger plug for an external charger is out of adjustment. (Operator is not present on seat GTR and EX machines Prior to Serial Number 100xxx)
7500	LCD Communication Error	The LCD lost communication to the controller. Check the 6 wire harness between the LCD module and it's connections.
7801-7802	Traction Motor Over Current	The traction motor output is exceeding its limit. Check to assure the parking brake is releasing when the throttle is engaged. Assure all wheels that contact the floor turn freely.
7804	Boost Mode	The code 7804 indicate the controller is in Boost Mode and considered normal under hard acceleration or when climbing a hill.
7900	Emergency Stop Activated	The emergency stop is activated. If the machine is not equipped with an emergency stop switch typically the LCD module has failed.

**BLANK**

THIS PAGE WAS INTENTIONALLY LEFT BLANK

**BLANK**  
THIS PAGE WAS INTENTIONALLY LEFT BLANK

***FACTORYCAT***<sup>®</sup>

1711 South Street  
Racine, WI 53404  
[www.factorycat.com](http://www.factorycat.com)  
Tel. US: 800-634-4060  
Tel. Int: (001) 262-681-3583